

BD-P1590  
BD-P1590C  
BD-P1600

# Blu-ray Disc Player user manual

imagine the possibilities

Thank you for purchasing this Samsung product.  
To receive more complete service,  
please register your product at  
[www.samsung.com/register](http://www.samsung.com/register)



# key features of your blu-ray disc player

---

## Player Features

### Supports a Variety of Disc Types

- Blu-ray (BD-ROM, BD-RE, BD-R), DVD Video, DVD-RW/-R (V mode and finalized only) discs and Audio CD.
- CD-RW/CD-R, DVD-RW/-R and USB memory flash stick content such as MP3 and JPEG files.

### HDMI (High Definition Multimedia Interface)

HDMI reduces picture noise by allowing a pure digital video/audio signal path from the player to your TV.

## Blu-ray Disc Features

Blu-ray Discs support the highest quality HD video available in the industry - Large capacity means no compromise on video quality. Furthermore, a Blu-ray Disc has the same familiar size and look as a DVD.

\* The following Blu-ray Disc features are disc dependant and will vary.  
Appearance and navigation of features will also vary from disc to disc.  
Not all discs will have the features described below.

### Video highlights

The BD-ROM format supports three highly advanced video codecs, including AVC, VC-1 and MPEG-2.

HD video resolutions are also available:

- 1920 x 1080 High Definition
- 1280 x 720 High Definition

### For High-Definition Playback

To view high-definition contents on a Blu-ray Disc, an HDTV (High Definition Television) is required.

Some Blu-ray Discs may require using the player's HDMI OUT to view high-definition content. The ability to view high-definition content on Blu-ray Discs may be limited depending on the resolution of your TV.

### Graphic planes

Two individual, full HD resolution (1920x1080) video layers are available on top of the HD video layer.

One layer is assigned to video-related graphics (like subtitles), and the other layer is assigned to interactive elements, such as buttons or menus. Various wipes, fades and scroll effects may be available on both layers.



### Menu graphics

Support full color resolution graphics and animation, thereby greatly surpassing the capabilities of DVD-Video. Unlike DVD, Menus can be accessed during video playback.

### Menu sounds

When you highlight or select a menu option on a disc, sounds can be heard such as button clicks or a voice-over explaining the highlighted menu choice.

**Multi-page/PopUp Menus**

Unlike DVD-Video, playback is not interrupted each time a new menu screen is accessed. Due to Blu-ray Disc's ability to preload data from the disc without interrupting playback, a menu may consist of several pages.

You can browse through the menu pages or select different menu paths, while the audio and video continues playing in the background.



**Interactivity**

Certain Blu-ray Discs may contain Animated menus and Trivia games.

**User Browsable Slideshows**

With Blu-ray Discs, you can browse through various still pictures while the audio remains playing.

**Subtitles**

Depending on what is contained on the Blu-ray Disc, you may be able to select different font styles, sizes and colors for the subtitles. Subtitles may also be animated, scrolled or faded in and out.

**BD-LIVE**

You can use a Blu-ray Disc supporting BD-LIVE through network connection to enjoy various contents provided by the disc manufacturer.

**BLOCKBUSTER**

This Blu-ray Disc Player enables you to enjoy movies on-demand provided by Blockbuster through a network connection.

**NETFLIX**

This Blu-ray Disc Player enables you to enjoy movies on-demand provided by Netflix through a network connection.

**PANDORA**

This Blu-ray Disc Player enables you to enjoy Internet Radio provided by Pandora through a network connection.







© 2005-2009 Pandora Media, Inc., All Rights Reserved Pandora and the Music Genome Project are registered trademarks of Pandora Media, Inc.

**YouTube**

This Blu-ray Disc Player enables you to enjoy videos on-demand provided by YouTube through a network connection.

**WHAT'S INCLUDED**

Check for the supplied accessories below.

 <p>Composite (Video), Audio L/R Cable (AC39-00073A)</p>		 <p>HDMI Cable (BD-P1590C only) (MF39-00299A)</p>		
 <p>User Manual (AK68-01783F)</p>	 <p>Quick Guide (AK68-01784F)</p>	 <p>Batteries for Remote Control (AAA Size) (AC43-12002H)</p>		
<p>Remote Control (AK59-00104K)</p>				

# safety information

## WARNING

TO REDUCE THE RISK OF ELECTRIC SHOCK, DO NOT REMOVE THE COVER(OR BACK).  
NO USER-SERVICEABLE PARTS ARE INSIDE. REFER SERVICING TO QUALIFIED SERVICE PERSONNEL.

	<p style="text-align: center;"><b>CAUTION</b> RISK OF ELECTRIC SHOCK DO NOT OPEN</p>	
<p>The lightning flash and Arrowhead within the triangle is a warning sign alerting you of dangerous voltage inside the product.</p>	<p><b>CAUTION:</b> TO REDUCE THE RISK OF ELECTRIC SHOCK, DO NOT REMOVE COVER (OR BACK) NO USER SERVICEABLE PARTS INSIDE. REFER SERVICING TO QUALIFIED SERVICE PERSONNEL.</p>	<p>The explanation point within the triangle is a warning sign alerting you of important instructions accompanying the product.</p>

## WARNING

- To reduce the risk of fire or electric shock, do not expose this appliance to rain or moisture.
- To prevent injury, this player must be securely attached to the floor/wall in accordance with the installation instructions.

### Note to CATV system installer

This reminder is provided to call CATV system installer's attention to Article 820-40 of the National Electrical Code (Section 54 of Canadian Electrical Code, Part I) that provides guidelines for proper grounding and, in particular, specifies that the cable ground shall be connected to the grounding system of the building as close to the point of cable entry as practical.

### FCC NOTE (for U.S.A):

This equipment has been tested and found to comply with the limits for a Class B digital device, pursuant to Part 15 of the FCC rules. These limits are designed to provide reasonable protection against harmful interference in a residential installation. This equipment generates, uses and can radiate radio frequency energy and, if not installed and used in accordance with the instructions, may cause harmful interference to radio or television reception, which can be determined by turning the equipment off and on.

The user is encouraged to try to correct the interference by one or more of the following measures.

- Reorient or relocate the receiving antenna.
- Increase the separation between the equipment and receiver.
- Connect this equipment into an outlet on a circuit different from that to which the receiver is connected.
- Consult the dealer or an experienced radio/TV technician for help.

This class B digital player meets all requirements of the Canadian Interference - Causing Equipment Regulations.

**CLASS 1 LASER PRODUCT**  
**KLASSE 1 LASER PRODUKT**  
**LUOKAN 1 LASER LAITE**  
**KLASS 1 LASER APPARAT**  
**PRODUCTO LÁSER CLASE 1**

### CLASS 1 LASER PRODUCT

Use of controls, adjustments or performance of procedures other than those specified herein may result in hazardous radiation exposure.

### CAUTION

THIS PRODUCT UTILIZES A LASER. USE OF CONTROLS OR ADJUSTMENTS OR PERFORMANCE OF PROCEDURES OTHER THAN THOSE SPECIFIED HEREIN MAY RESULT IN HAZARDOUS RADIATION EXPOSURE. DO NOT OPEN COVER AND DO NOT REPAIR YOURSELF. REFER SERVICING TO QUALIFIED PERSONNEL.

**Note:**

- This unit can be used only where the power supply is AC 120V, 60Hz. It cannot be used elsewhere.
- This Blu-ray Disc Player is designed and manufactured to respond to the Region Management Information. If the Region number of a Blu-ray Disc/DVD disc does not correspond to the Region number of this Blu-ray Disc Player, the Blu-ray Disc Player cannot play the disc.
- The product unit accompanying this user manual is licensed under certain intellectual property rights of certain third parties. This product is covered by one or more of the following U.S. patents:  
5,060,220 5,457,669 5,561,649 5,705,762 6,043,912 6,438,099 6,467,061 6,556,521 6,578,163 6,697,307  
6,728,474 6,771,891 6,894,963 6,895,593 6,937,815 6,996,327 7,009,926 7,085,221 7,088,649 7,092,327  
7,099,566 7,123,564 7,142,493 7,142,495 7,145,861 7,146,624 7,151,729 7,161,879 7,164,647 7,167,437  
7,173,891 7,177,250 7,194,187 7,203,891 7,209,423 7,210,067 7,228,062 7,245,566 7,245,567 7,257,065  
7,263,045 7,269,110 7,272,086 7,272,106 7,280,460 7,283,729 7,286,454 7,304,938  
This product is covered by the following U.S. patents:  
US4,930,158 US4,930,160

This license is limited to private non-commercial use by end-user consumers for licensed contents. No rights are granted for commercial use. The license does not cover any product unit other than this product unit and the license does not extend to any unlicensed product unit or process conforming to ISO/IEC 11172-3 or ISO/IEC 13818-3 used or sold in combination with this product unit. The license only covers the use of this product unit to encode and/or decode audio files conforming to the ISO/IEC 11172-3 or ISO/IEC 13818-3. No rights are granted under this license for product features or functions that do not conform to the ISO/IEC 11172-3 or ISO/IEC 13818-3.

## PRECAUTIONS

---

### Important Safety Instructions

Read these operating instructions carefully before using the unit. Follow all the safety instructions listed below. Keep these operating instructions handy for future reference.

- 1) Read these instructions.
- 2) Keep these instructions.
- 3) Heed all warnings.
- 4) Follow all instructions.
- 5) Do not use this player near water.
- 6) Clean only with dry cloth.
- 7) Do not block any ventilation openings, install in accordance with the manufacturer's instructions.
- 8) Do not install near any heat sources such as radiators, heat registers, or other player (including amplifiers) that produce heat.
- 9) The polarized or the grounding type plug has an important safety purpose. A polarized plug has two blades with one wider than the other. A grounding type plug has two blades and a third grounding prong. The wide blade or the third prong is provided for your safety. If the provided plug does not fit into your outlet, consult an electrician for replacement of the obsolete outlet.
- 10) Protect the power cord from being deformed or pinched particularly at plugs, convenience receptacles, and the point where they exit from the player.
- 11) Only use attachments/accessories specified by the manufacturer.
- 12) Use only with the cart, stand, tripod, bracket, or table specified by the manufacturer, or sold with the player. When a cart is used, use caution when moving the cart/player combination to avoid injury from tip-over.
- 13) Unplug this player during lightning storms or when unused for long periods of time.
- 14) Refer all servicing to a qualified service personnel. Servicing is required when the player has been damaged in any way, such as power-supply cord or plug is damaged, liquid has been spilled or objects have fallen into the player, the player has been exposed to rain or moisture, does not operate normally, or has been dropped.



# safety information

---

## Handling Cautions

- Before connecting other components to this Blu-ray Disc Player, be sure to turn them all off.
- Do not move the Blu-ray Disc Player while a disc is being played as the disc may be scratched or broken, or the Blu-ray Disc Player's internal parts may be damaged.
- Do not put a flower vase filled with water or any small metal objects on the Blu-ray Disc Player.
- Be careful not to put your hand into the disc tray.
- Do not place anything other than the disc in the disc tray.
- Exterior interferences such as lightning and static electricity can affect the normal operation of this Blu-ray Disc Player. If this occurs, turn the Blu-ray Disc Player off and on again with the **POWER** button, or disconnect and then reconnect the AC power cord to the AC power outlet. The Blu-ray Disc Player will operate normally.
- Be sure to remove the disc and turn off the Blu-ray Disc Player after use.
- Disconnect the AC power cord from the AC outlet when you don't intend to use the Blu-ray Disc Player for long periods of time.
- To clean a disc, wipe it in a straight line from the inside to the outside of the disc.
- Do not expose the player to any liquid.
- When the AC plug is connected to a wall outlet, the player will still draw power (standby mode) when it is turned off.
- Apparatus shall not be exposed to dripping or splashing and no objects filled with liquids, such as vases, shall be placed on the apparatus.
- The Mains plug is used as a disconnect device and shall stay readily operable at any time.

## Maintenance of Cabinet

For safety reasons, be sure to disconnect the AC power cord from the AC outlet.

- Do not use benzene, thinner, or other solvents for cleaning.
- Wipe the cabinet with a soft cloth.

## Restrictions on Playback

- This player may not respond to all operating commands because some Blu-ray, DVD and CD discs allow specific or limited operation and features during playback.  
Please note that this is not a defect in the player.
- Samsung cannot assure that this player will play every disc bearing the Blu-ray Disc, DVD or CD logo because disc formats evolve, and problems and errors may occur during the creation of Blu-ray Disc, DVD, CD software and/or the manufacture of discs.  
Please contact the SAMSUNG customer care center if you have questions or encounter difficulty in playing Blu-ray Disc, DVD, CD discs in this player. Also, refer to rest of this Manual for additional information on playback restrictions.

# contents

---

## KEY FEATURES OF YOUR BLU-RAY DISC PLAYER

2

3 What's included

## SAFETY INFORMATION

4

4 Warning

5 Precautions

## GETTING STARTED

10

10 Before Using the User's Manual

11 Disc Type and Characteristics

14 Disc Storage & Management

## DESCRIPTION

15

15 Front Panel

16 Front Panel Display

17 Rear Panel

## REMOTE CONTROL

18

18 Tour of the Remote Control

19 Setting the Remote Control

19 Regarding the Battery

20 Controllable TV Codes

## CONNECTIONS

21

21 Connecting to a TV with an HDMI Cable  
- BEST QUALITY (RECOMMENDED)

23 Connecting to a TV with DVI Cable  
- BEST QUALITY (RECOMMENDED)

24 Connecting to a TV (Component)  
- BETTER QUALITY

25 Connecting to a TV (Video)  
- GOOD QUALITY

26 Connecting to an Audio System  
(HDMI supported Amplifier)  
- BEST QUALITY (RECOMMENDED)

27 Connecting to an Audio System  
(Dolby Digital, DTS Amplifier)  
- BETTER QUALITY

28 Connecting to an Audio System  
(2 Channel Amplifier) - GOOD QUALITY

29 Connecting to the network

## BASIC FUNCTIONS OF YOUR BLU-RAY DISC PLAYER

31

31 Before Playing

32 On-Screen Menu Navigation

33 Playing a Disc

33 Setting the Sound

34 Using the Search and Skip Functions

34 Slow Motion Play/Step Motion Play

# contents

---

<b>SYSTEM SETUP</b>	35	Setting the Clock
35		
<b>LANGUAGE SETUP</b>	36	Setting up the Language Options
36		
<b>AUDIO SETUP</b>	37	Setting up the Audio Options
37		
<b>DISPLAY SETUP</b>	40	Setting up the display Options
40		
<b>HDMI SETUP</b>	44	Setting up the HDMI setup options
44		
<b>PARENTAL SETUP</b>	47	Setting up the Parental Lock
47		
<b>NETWORK SETUP</b>	49	Setting up the Network Setup Options
49		
<b>BD DATA MANAGEMENT</b>	54	System Device Management
54		
<b>SYSTEM UPGRADE</b>	55	Firmware Upgrade
55	57	System Information
	57	Firmware upgrade notification
55		



<b>WATCHING A MOVIE</b>	
58	Using the Display Function
59	Using the Disc Menu & Popup/Title Menu
60	Repeat Play
61	Selecting the Audio Language
61	Selecting the Subtitle Language
62	Changing the Camera Angle
63	BONUSVIEW Settings
63	BD-LIVE™
<b>LISTENING TO MUSIC</b>	
64	Buttons on the Remote Control used for Audio CD (CD-DA)/MP3 playback
64	Repeat Audio CD(CD-DA)/MP3
65	Playing an Audio CD(CD-DA)/MP3
<b>PLAYING BACK A PICTURE</b>	
68	Playing a JPEG disc
<b>USING THE E-CONTENTS</b>	
69	Using Blockbuster
70	Using Netflix
72	Using Pandora
74	Using YouTube
<b>APPENDIX</b>	
80	Troubleshooting
82	Specifications

# getting started





---

## BEFORE USING THE USER'S MANUAL

---

Make sure to check the following terms before using the user's manual.

### Icons that will be used in this manual

Icon	Term	Definition
	BD-ROM	This involves a function available on a BD-ROM.
	BD-RE	This involves a function available on a BD-RE.
	BD-R	This involves a function available on a BD-R.
	DVD-VIDEO	This involves a function available on DVD-Video or DVD-RW/-R discs that have been recorded and finalized in Video Mode.
	DVD-RW	This involves a function available on DVD-RW. (V mode and finalized only)
	DVD-R	This involves a function available on DVD-R. (V mode and finalized only)
	Audio CD	This involves a function available on an audio CD-RW/CD-R (CD-DA format).
	MP3	This involves a function available on DVD-RW/-R, CD-RW/CD-R discs and USB memory flash sticks.
	JPEG	This involves a function available on DVD-RW/-R, CD-RW/CD-R discs and USB memory flash sticks.
	USB memory flash stick	This involves a function available on USB memory flash stick.
	Note	This involves tips or instructions on the page that help each function operate.

### About the use of this user's manual

---

- 1) Be sure to be familiar with Safety Instructions before using this product. (See pages 4-6)
- 2) If a problem occurs, check the Troubleshooting section. (See pages 80-81)

### Copyright





---

©2009 Samsung Electronics Co.,Ltd.

All rights reserved; No part or whole of this user's manual may be reproduced or copied without the prior written permission of Samsung Electronics Co.,Ltd.









## DISC TYPE AND CHARACTERISTICS

### Disc types that can be played

Disc Types	Disc Logo	Recorded content	Disc Shape	Max. Playing minute
BD-ROM BD-RE/BD-R		AUDIO + VIDEO	Single sided	Playing time depends on the Title
DVD-VIDEO		AUDIO + VIDEO	Single sided(5 inches)	240
			Double sided(5 inches)	480
			Single sided(3 1/2 inches)	80
			Double sided(3 1/2 inches)	160
DVD-RW (V mode and finalized only)		AUDIO + VIDEO	5 inches (4.7GB)	480 (EX : Extended Play)
DVD-R (V mode and finalized only)		AUDIO + VIDEO	5 inches (4.7GB)	480 (EX : Extended Play)
AUDIO-CD		AUDIO	Single sided(5 inches)	74
			Single sided (3 1/2 inches)	20

- This player is compatible with the NTSC color system only.
- PAL discs will not play.

### Logos of Discs that can be played

			
Blu-ray Disc	DTS-HD Master Audio	Digital Audio	BD-LIVE
			
Dolby TrueHD	NTSC broadcast system in U.S.A, Canada, Korea, Japan	Stereo	Java

### Discs that cannot be played

- Blu-ray Discs with a region code other than "Region A".
- DVD-Video with a region number other than "1" or "ALL"
- HD DVD
- DVD+RW/+R
- DVD-RAM
- DVD-RW(VR mode)
- 3.9 GB DVD-R Disc for Authoring.
- DVD-ROM/PD/MV-Disc, etc
- Super Audio CD(except CD layer)
- CVD/CD-ROM/CDV/CD-G/CD-I/LD (CDGs play audio only, not graphics.)



# getting started

## [Note]

- Some commercial discs and DVD discs purchased outside your region may not be playable with this product. When these discs are played, either "This disc can not be played." or "Please check the regional code of the disc." will be displayed.
- If a DVD-RW/-R disc has not been recorded properly in DVD video format, it will not be playable.
- The unit cannot play CD-RW/CD-R and DVD-RW/-R and USB memory flash stick content such as divx, avi, mpg, mov.

## Region code

Both the Blu-ray Disc Player and the discs are coded by region. These regional codes must match in order to play the disc. If the codes do not match, the disc will not play. The Region Number for this Blu-ray Disc Player is described on the rear panel of the Blu-ray Disc Player.

Disc Type	Blu-ray	DVD-VIDEO
Region code		

Blu-ray Disc Region Code	Area
A	North America, Central America, South America, Korea, Japan, Taiwan, Hong Kong and South East Asia.
B	Europe, Greenland, French territories, Middle East, Africa, Australia and New Zealand.
C	India, China, Russia, Central and South Asia.

DVD Region Code	Area
1	The U.S., U.S. territories and Canada
2	Europe, Japan, the Middle East, Egypt, South Africa, Greenland
3	Taiwan, Korea, the Philippines, Indonesia, Hong Kong
4	Mexico, South America, Central America, Australia, New Zealand, Pacific Islands, Caribbean
5	Russia, Eastern Europe, India, most of Africa, North Korea, Mongolia
6	China

## Blu-ray Disc Compatibility

Blu-ray Disc is a new and evolving format. Accordingly, disc compatibility issues are possible. Not all discs are compatible and not every disc will play back. For additional information, refer to the Compliance and Compatibility Notice section of this Manual. If you encounter compatibility problems, please contact the SAMSUNG customer care center at 1-800 SAMSUNG.



- Playback may not work for some types of discs, or when specific operations, such as angle change and aspect ratio adjustment, are being performed. Information about the discs is written in detail on the disc box. Please refer to this if necessary.
- Do not allow the disc to become dirty or scratched. Fingerprints, dirt, dust, scratches or deposits of cigarette smoke on the recording surface may make it impossible to use the disc for playback.
- Discs with PAL programs recorded on them cannot be played using this product.
- When a BD-J title is played, loading may take longer than a normal title, or some functions may perform slowly.

## Disc Types

---

### ❖ BD-ROM

This Blu-ray disc can only be played back. A BD-ROM disc contains pre-recorded data. Although a BD-ROM may contain any form of data, most BD-ROM discs will contain movies in High Definition format for playback on Blu-ray Disc Player's. This unit can play back pre-recorded commercial BD-ROM discs.

### ❖ BD-RE/BD-R

Blu-ray Disc Rewritable/Blu-ray Disc Recordable. BD-RE/BD-R is the ideal format for making backups, or recording personal video.

### ❖ DVD-Video

- A digital versatile disc (DVD) can contain up to 135-minutes of images, 8 audio languages and 32 subtitle languages. It is equipped with MPEG-2 picture compression and Dolby Digital surround, allowing you to enjoy vivid and clear theatre quality images.
- When switching from the first layer to the second layer of a dual-layered DVD Video disc, there may be momentary distortion in the image and sound. This is not a malfunction of the unit.
- Once a DVD-RW/-R recorded in Video Mode is finalized, it becomes DVD-Video. Pre-recorded (pre-stamped) commercial DVDs with movies are also referred to as DVD-Videos. This unit can play back pre-recorded commercial DVD discs (DVD-Video discs) with movies.

### ❖ Audio CD

- An audio disc on which 44.1kHz PCM Audio is recorded.
- This unit can play back CD-DA format audio CD-RW and CD-R discs.
- The unit may not be able to play some CD-RW or CD-R discs due to the condition of the recording.

### ❖ CD-RW/CD-R

- Use a 700MB(80 minutes) CD-RW/CD-R disc. If possible, do not use a 800MB(90 minutes) or above disc, as the disc may not play back.
- If the CD-RW/CD-R disc was not recorded as a closed session, you may experience delays when playing back the beginning of the disc or all recorded files may not play.
- Some CD-RW/CD-R discs may not be playable with this unit, depending on the device which was used to burn them. For contents recorded on CD-RW/CD-R media from CDs for your personal use, playability may vary depending on contents and discs.

### ❖ DVD-R Disc Playback

- Once a DVD-R recorded in Video Mode is finalized, it becomes DVD-Video.
- This unit can play back DVD-R discs recorded and finalized with a DVD video recorder. It may not be able to play some DVD-R discs depending on the disc and the condition of the recording.

### ❖ DVD-RW Disc Playback

- Playback can be performed with DVD-RW discs recorded in the Video Mode and finalized.
- Once a DVD-RW recorded in Video Mode is finalized, it becomes DVD-Video. Ability to play back may depend on recording conditions.

## Disc Format

---

### ❖ DVD-RW/-R (V)

- This is a format that is used for recording data on a DVD-RW or DVD-R disc. The disc can be played by this Blu-ray Disc Player once it has been finalized.

### ❖ AVCHD (Advanced Video Codec High Definition)

- This player can playback AVCHD format discs. These discs are normally recorded and used in camcorders.
- The AVCHD format is a high definition digital video camera format.
- The MPEG-4 AVC/H.264 format is capable of compressing images at higher efficiency than that of the conventional image compressing format.
- Some AVCHD discs use the "x.v.Color" format.
- This player can playback AVCHD discs using "x.v.Color" format.
- "x.v.Color" is a trademark of Sony Corporation.
- "AVCHD" and the AVCHD logo are trademarks of Matsushita Electronic Industrial Co., Ltd. and Sony Corporation.

# getting started

---

- ✍️ ■ Some AVCHD format discs may not play, depending on the recording condition. AVCHD format discs need to be finalized.
  - “x.v.Color” offers a wider color range than normal DVD camcorder discs.

## DISC STORAGE & MANAGEMENT

---

### Disc Handling

---

#### ❖ Disc Shape

- Use discs with regular shapes. If an irregular disc (a disc with a special shape) is used, this Blu-ray Disc Player may be damaged.

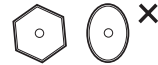

#### ❖ Holding discs

- Avoid touching the surface of a disc where recording is performed.



#### ❖ Blu-ray Discs

- If the player is not used for a long period of time, remove the Blu-ray Disc from the player and store it in its case.
- Be careful not to leave fingerprints or scratches on the surface of the Blu-ray Disc.

#### ❖ DVD-RW and DVD-R

- Clean with an optional PD disc cleaner (LF-K200DCA1 where available). Do not use cleaners or cloths for CDs to clean DVD-RW/-R discs.

#### ❖ DVD-Video, Audio-CD

- Wipe off dirt or contamination on the disc with a soft cloth.

#### ❖ Cautions on handling discs

- Do not write on the printed side with a ball-point pen or pencil.
- Do not use record cleaning sprays or antistatic. Also, do not use volatile chemicals, such as benzene or thinner.
- Do not apply labels or stickers to discs. (Do not use discs fixed with exposed tape adhesive or leftover peeled-off stickers.)
- Do not use scratch-proof protectors or covers.
- Do not use discs printed with label printers available on the market.
- Do not load warped or cracked discs.



### Disc Storage

---

Be careful not to damage the disc because the data on these discs is highly vulnerable to the environment.

- Do not keep under direct sunlight.
- Keep in a cool ventilated area.
- Store vertically.
- Keep in a clean protection jacket.
- If you move your Blu-ray Disc Player suddenly from a cold place to a warm place, condensation may generate on the operating parts and lens and cause abnormal disc playback. If this occurs, wait for two hours before connecting the plug to the power outlet. Then insert the disc and try to play back again.

# description

## FRONT PANEL

### ❖ BD-P1590/P1590C

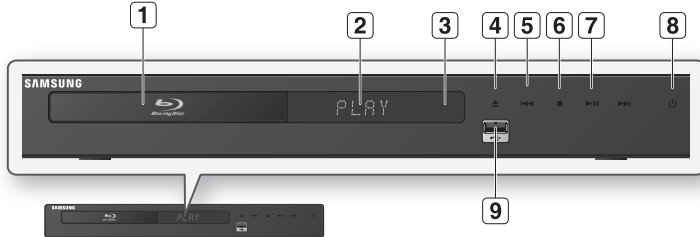

### ❖ BD-P1600

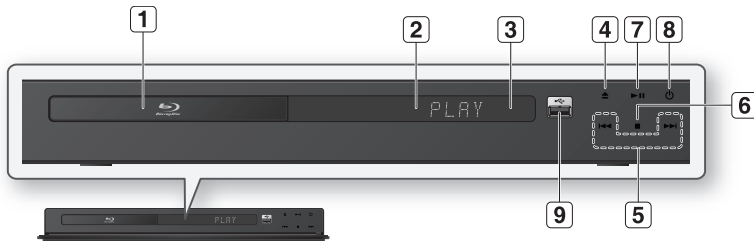

<b>1</b>	<b>DISC TRAY</b>	Opens to accept a disc.
<b>2</b>	<b>DISPLAY</b>	Displays the playing status, time, etc.
<b>3</b>	<b>REMOTE CONTROL SENSOR</b>	Detects signals from the remote control.
<b>4</b>	<b>OPEN/CLOSE BUTTON</b>	Opens and closes the disc tray.
<b>5</b>	<b>SEARCH/SKIP BUTTONS</b>	Goes to the next title/chapter/track or goes back to the previous title/chapter/track.
<b>6</b>	<b>STOP BUTTON</b>	Stops disc playback.
<b>7</b>	<b>PLAY/PAUSE BUTTON</b>	Plays a disc or pauses playback.
<b>8</b>	<b>POWER BUTTON</b>	Turns the Blu-ray Disc Player on and off.
<b>9</b>	<b>USB HOST</b>	A USB memory flash stick can be connected here and used as storage when connected to BD-LIVE. It can also be used for firmware upgrades and MP3/JPEG playback.

- ☑ You must use the USB HOST on the rear panel of the Blu-ray Disc Player to connect a wireless LAN Adapter.
- You cannot use USB memory flash stick simultaneously in both the front and rear USB ports.

# description

## FRONT PANEL DISPLAY

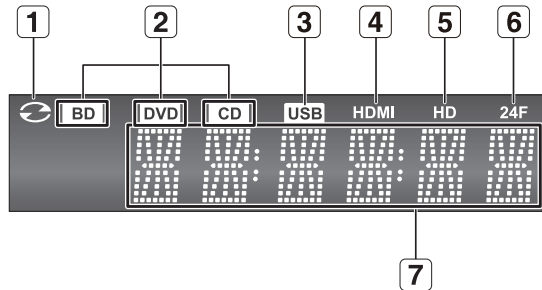

<b>1</b>	<b>IN DISC INDICATOR</b>	Lights when a disc is in the tray.
<b>2</b>	<b>DISC TYPE INDICATORS</b>	Lights to indicate the disc type in the tray.
<b>3</b>	<b>USB INDICATOR</b>	Lights to indicate when USB is connected.
<b>4</b>	<b>HDMI INDICATOR</b>	Lights to indicate when HDMI is connected.
<b>5</b>	<b>HD INDICATOR</b>	Indicates the display output is HD (High Definition).
<b>6</b>	<b>24F INDICATOR</b>	Indicates the current mode is 24Fs (24 frames per second).
<b>7</b>	<b>STATUS INDICATOR</b>	Playing time/current status indicator.



## REAR PANEL

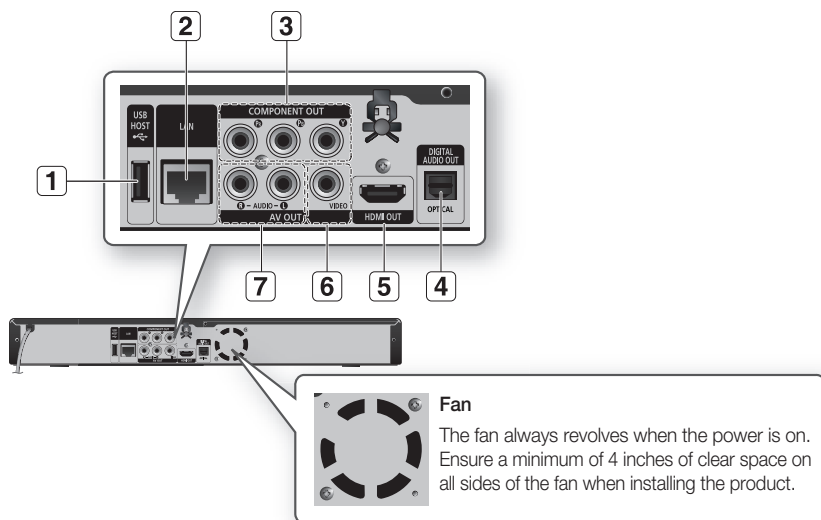

<b>1</b> USB HOST	A USB memory flash stick can be connected here and used as storage when connected to BD-LIVE. It can also be used for firmware upgrades and MP3/JPEG playback, as well as for connecting to BD-LIVE with a wireless LAN adapter.
<b>2</b> LAN	Can be used for connection to BD-LIVE, Blockbuster, Netflix, Pandora and YouTube. It can be also used for firmware upgrades.
<b>3</b> COMPONENT VIDEO OUT	Connects to equipment having Component video input.
<b>4</b> DIGITAL AUDIO OUT (OPTICAL)	Connects to a Receiver.
<b>5</b> HDMI OUT	Using an HDMI cable, connect this HDMI output terminal to the HDMI input terminal on your TV for the best quality picture and to your Receiver for the best quality sound.
<b>6</b> VIDEO OUT	Connects the input of external equipment using a video cable.
<b>7</b> AUDIO OUT	Connects to the audio input of external equipment using audio cables.

- 
 Software upgrades using the USB Host jack must be performed with a USB memory flash stick only.
- Oversized USB drives may not be able to be inserted when a LAN or HDMI cable is connected.
- A USB device consuming more than 500mA requires a separate power supply device for normal operation.

# remote control

## TOUR OF THE REMOTE CONTROL

### Installing batteries in the Remote Control

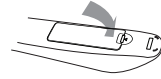
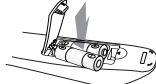

- Lift the cover at the back of the remote control upward as shown.**
- Install two AAA size batteries.**  
Make sure to match the "+" and "-" ends of the batteries with the diagram inside the compartment.
- Replace the cover.**  
Assuming typical TV usage, the batteries last for about one year.

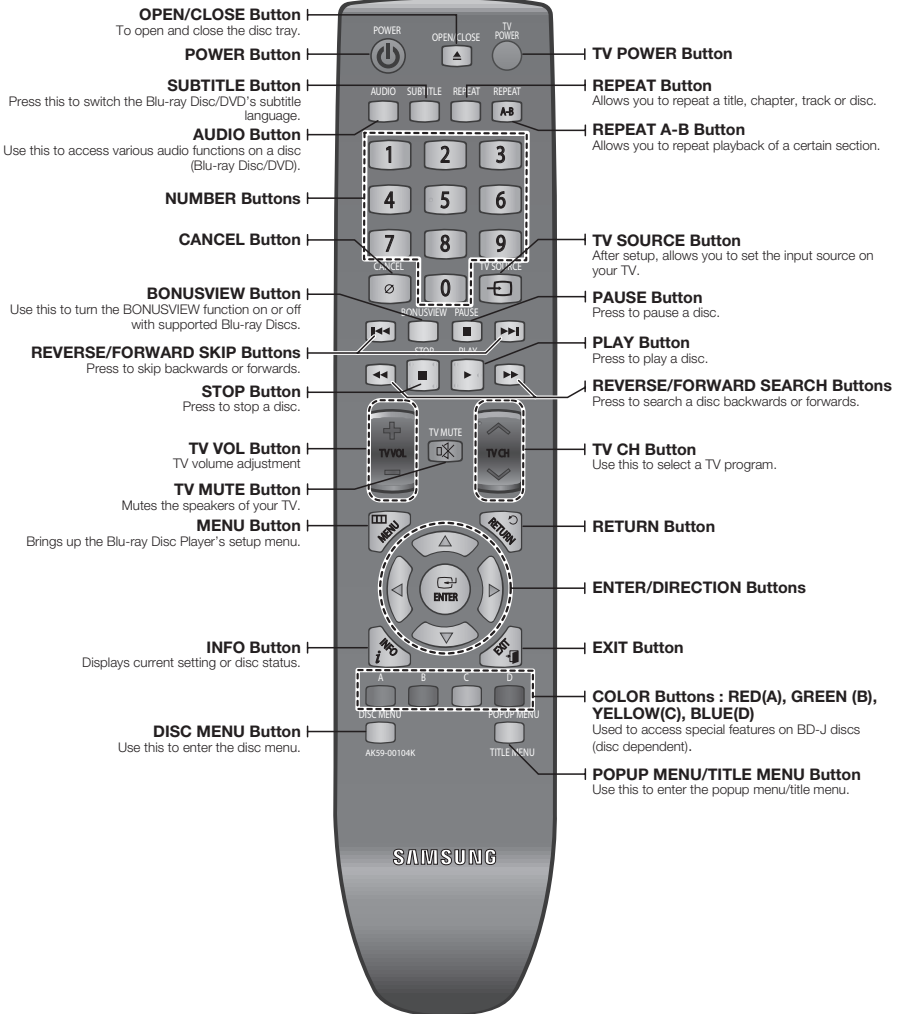

## SETTING THE REMOTE CONTROL

You can control certain functions of your TV with this remote control.

Control function buttons include : **TV POWER**, **TV CH  $\wedge/\vee$** , **TV VOL +/-**, **TV MUTE**, **TV SOURCE** button.

**To determine whether your television is compatible, follow the instructions below.**

1. Switch your television on.
2. Point the remote control towards the television.
3. Press and hold the **TV POWER** button and enter the two-figure code corresponding to the brand of your television by pressing the appropriate number buttons. (see the next page for the code list).  
If your television is compatible with the remote control, it will switch off.  
It is now programmed to operate with the remote control.

- ✍ ■ If several codes are indicated for your television brand, try each one in turn until you find one that works.
- If you replace the remote control's batteries, you must set the brand code again.

**You can then control the television using the following buttons after pressing the TV button.**

Button	Function
TV POWER	Used to switch the television on and off.
TV SOURCE	Used to select an external source.
TV VOL (+/-)	Used to adjust the volume of the television.
TV CH ( $\wedge/\vee$ )	Used to select the desired channel.
TV MUTE	Used to toggle the sound on and off.

- ✍ ■ The functions listed above will not necessarily work on all televisions. If you encounter problems, operate the television directly.

## REGARDING THE BATTERY

**If the remote does not operate properly:**

- Check the polarity +/- of the batteries (Dry-Cell)
- Check if the batteries are drained.
- Check if remote sensor is blocked by obstacles.
- Check if there is any fluorescent lighting nearby.

**Dispose of batteries according to local environmental regulations. Do not put them in the household trash.**

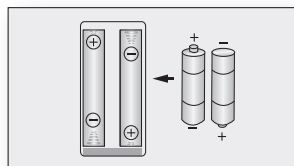

# remote control

## CONTROLLABLE TV CODES

Brand	Code
SAMSUNG	TV POWER+01, +02, +03, +04, +05, +06, +07, +08, +09
AIWA	TV POWER+82
ANAM	TV POWER+10, +11, +12, +13, +14, +15, +16, +17, +18
BANG & OLUFSEN	TV POWER+57
BLAUPUNKT	TV POWER+71
BRANDT	TV POWER+73
BRIONVEGA	TV POWER+57
CGE	TV POWER+52
CONTINENTAL EDISON	TV POWER+75
DAEWOO	TV POWER+19, +20, +23, +24, +25, +26, +27, +28, +29, +30, +31, +32, +33, +34
EMERSON	TV POWER+64
FERGUSON	TV POWER+73
FINLUX	TV POWER+06, +49, +57
FORMENTI	TV POWER+57
FUJITSU	TV POWER+84
GRADIENTE	TV POWER+70
GRUNDIG	TV POWER+49, +52, +71
HITACHI	TV POWER+60, +72, +73, +75
IMPERIAL	TV POWER+52
JVC	TV POWER+61, +79
LG	TV POWER+06, +19, +20, +21, +22, +78
LOEWE	TV POWER+06, +69
LOEWE OPTA	TV POWER+06, +57
MAGNAVOX	TV POWER+40
METZ	TV POWER+57
MITSUBISHI	TV POWER+06, +48, +62, +65
MIVAR	TV POWER+52, +77
NEC	TV POWER+83
NEWSAN	TV POWER+68
NOBLEX	TV POWER+66
NOKIA	TV POWER+74
NORDMENDE	TV POWER+72, +73, +75
PANASONIC	TV POWER+53, +54, +74, +75
PHILIPS	TV POWER+06, +55, +56, +57
PHONOLA	TV POWER+06, +56, +57
PIONEER	TV POWER+58, +59, +73, +74
RADIOLA	TV POWER+06, +56
RADIOMARELLI	TV POWER+57
RCA	TV POWER+45, +46
REX	TV POWER+74
SABA	TV POWER+57, +72, +73, +74, +75
SALORA	TV POWER+74
SANYO	TV POWER+41, +42, +43, +44, +48
SCHNEIDER	TV POWER+06
SELECO	TV POWER+74
SHARP	TV POWER+36, +37, +38, +39, +48
SIEMENS	TV POWER+71
SINGER	TV POWER+57
SINUDYNE	TV POWER+57
SONY	TV POWER+35, +48
TELEAVA	TV POWER+73
TELEFUNKEN	TV POWER+67, +73, +75, +76
THOMSON	TV POWER+72, +73, +75
THOMSON ASIA	TV POWER+80, +81
TOSHIBA	TV POWER+47, +48, +49, +50, +51, +52
WEGA	TV POWER+57
YOKO	TV POWER+06
ZENITH	TV POWER+63

# connections

This section involves various methods of connecting the Blu-ray Disc Player to other external components such as a TV.

## CONNECTING TO A TV WITH AN HDMI CABLE - BEST QUALITY (RECOMMENDED)

1. Using an HDMI cable, connect the **HDMI OUT** terminal on the rear of the Blu-ray Disc Player to the **HDMI IN** terminal of your TV.
2. Press the input selector on your TV remote control until the HDMI signal from the Blu-ray Disc Player appears on your TV screen.
  - If you have set the remote control to operate your TV (see pages 19~20), press the **TV SOURCE** button on the remote control and select HDMI as the external source of the TV.

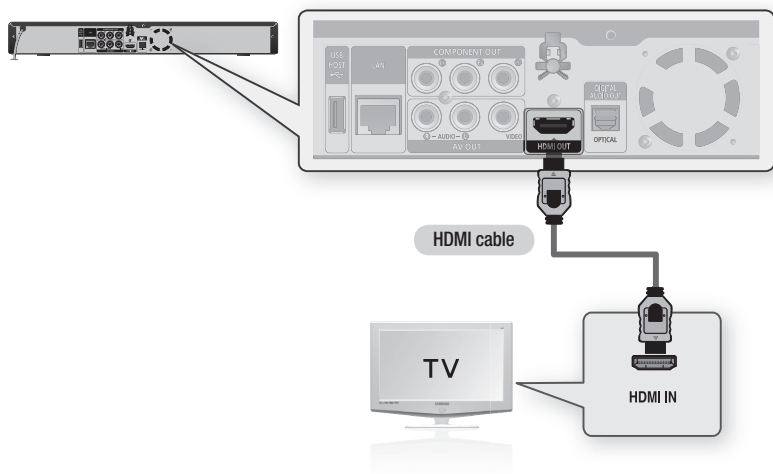

- If the Blu-ray Disc Player is connected to your TV in HDMI 1080p output mode, you must use a High speed(category2) HDMI cable.
- If the HDMI cable is connected or removed during playback of a CD-DA, the player will stop playing.

## HDMI Auto Detection Function

---

The player's video output will automatically change to HDMI output resolution when connecting an HDMI cable while power is on (see page 42).



- Depending on your TV, certain HDMI output resolutions may not work. Please refer to the user's manual of your TV.
- If an HDMI cable is connected from the player to a TV, the Blu-ray Disc Player's output is set to HDMI output resolution automatically within 10 seconds.
- If Component and HDMI are both connected, HDMI mode is automatically selected. (See page 42)
- When you connect the player to the TV using the HDMI cable for the first time or to a new TV, the HDMI output resolution will automatically be set to the highest provided by the TV.
- If you connect a Samsung TV to the Blu-ray Disc Player using an HDMI cable, the player can be easily operated using the TV remote control. (This is only available with Samsung TVs that support the Anynet+ feature.) (See pages 44~45)

### • HDMI (High Definition Multimedia Interface)

HDMI is an interface that enables the digital transmission of video and audio data with just a single connector.

Using HDMI, the Blu-ray Disc Player transmits a digital video and audio signal and displays a vivid picture on a TV having an HDMI input jack.

### • HDMI connection description

HDMI connector - Supports video and digital audio data (LPCM or Bitstream).

- HDMI outputs only a pure digital signal to the TV.

- If your TV does not support HDCP (High-bandwidth Digital Content Protection), random noise appears on the screen.

### • Why does Samsung use HDMI?

Analog TVs require an analog video/audio signal. However, when playing a Blu-ray Disc/DVD, the data transmitted to a TV is digital. Therefore either a digital-to-analog converter (in the Blu-ray Disc Player) or an analog-to-digital converter (in the TV) is required. During this conversion, the picture quality is degraded due to noise and signal loss. HDMI technology is superior because it requires no D/A conversion and is a pure digital signal from the player to your TV.

### • What is the HDCP?

HDCP (High-band width Digital Content Protection) is a system for protecting Blu-ray Disc/DVD content outputted via HDMI from being copied. It provides a secure digital link between a video source (PC, DVD, etc) and a display device (TV, projector, etc). Content is encrypted at the source device to prevent unauthorized copies from being made.

### • What is Anynet+?

Anynet+ is a convenient function that offers linked operation of this unit through Samsung TVs with the Anynet+ feature.

- If your Samsung TV has an *Anynet+* logo, then it supports the Anynet+ function.

- If you turn on the player and insert a disc, the player will start playing the disc, and the TV will turn on automatically and switch to HDMI mode.

- If you turn on the player and press the **PLAY** button with a disc already inserted, the TV will immediately turn on and switch to HDMI mode.

### • What is BD Wise?

BD Wise is Samsung's latest inter-connectivity feature.

- When you connect Samsung products with BD-Wise to each other via HDMI, the optimum resolution will be set automatically.

## CONNECTING TO A TV WITH DVI CABLE - BEST QUALITY (RECOMMENDED)

1. Using an HDMI-DVI cable (not included), connect the **HDMI OUT** terminal on the rear of the Blu-ray Disc Player to the **DVI IN** terminal of your TV.
2. Using the audio cables, connect the **AUDIO (red and white) OUT** terminals on the rear of the Blu-ray Disc Player to the **AUDIO (red and white) IN** terminals of your TV.  
Turn on the Blu-ray Disc Player and TV.
3. Press the input selector on your TV remote control until the DVI signal from the Blu-ray Disc Player appears on your TV screen.
  - If you have set the remote control to operate your TV (see pages 19~20), press the **TV SOURCE** button on the remote control and select HDMI as the external source of the TV.

Connecting the HDMI cable while the Blu-ray Disc Player's power is on will result in the player's video output being changed to HDMI mode automatically (see page 42).



- Depending on your TV, certain HDMI output resolutions may not work. Please refer to the user's manual of your TV.
- If an HDMI-DVI cable is plugged into the TV, the Blu-ray Disc Player's output resolution is set to HDMI automatically within 10 seconds.
- If Component and HDMI are both connected, HDMI mode is automatically selected. (See page 42)
- When you connect the player to the TV using the HDMI cable for the first time or to a new TV, the HDMI output resolution will automatically be set to the highest provided by the TV
- If the HDMI cable is connected or removed during playback of a CD-DA, the player will stop playing.

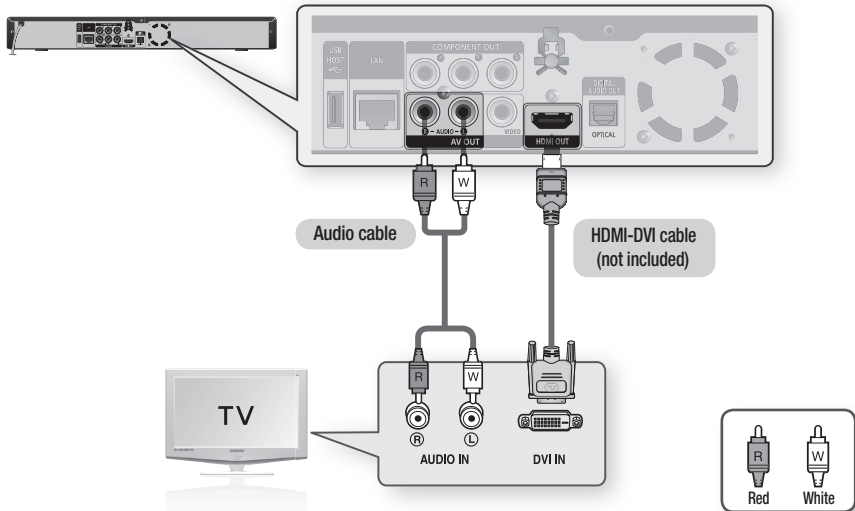

# connections

## CONNECTING TO A TV (COMPONENT) - BETTER QUALITY

- Connecting to your TV using Component video cables.

- You will enjoy high quality images with accurate color reproduction. Component video separates the picture element into black and white(Y), blue(Pb) and red(Pb) signals to present clear and clean images. (Audio signals are delivered through the audio output.)

1. Using Component video cables (not included) , connect the **COMPONENT VIDEO OUT** terminals on the rear of the Blu-ray Disc Player to the **COMPONENT IN** terminals of your TV.
2. Using the audio cables, connect the **AUDIO (red and white) OUT** terminals on the rear of the Blu-ray Disc Player to the **AUDIO (red and white) IN** terminals of your TV. Turn on the Blu-ray Disc Player and TV.
3. Press the input selector on your TV remote control until the Component signal from the Blu-ray Disc Player appears on the TV screen.
  - If you have set the remote control to operate your TV (see pages 19~20), press the **TV SOURCE** button on the remote control and select **COMPONENT** as the external source of the TV.

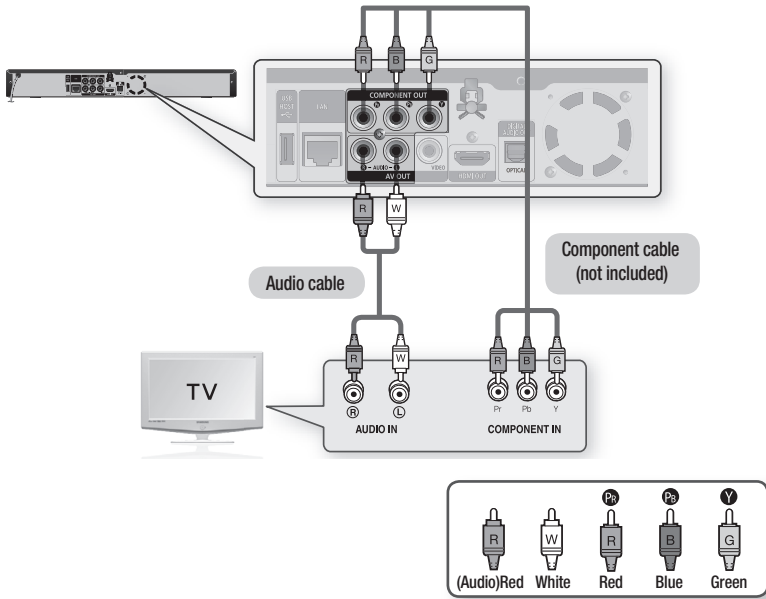

- Depending on the manufacturer, the component terminals on your TV may be marked "R-Y, B-Y, Y" or "Cr, Cb, Y" instead of "Pb, Pr, Y". The number and position of terminals may vary depending on the TV set. Please refer to the user's manual of your TV.
- You can select from a variety of resolution settings for Blu-ray Discs such as 1080i, 720p, 480p and 480i, depending on the disc type. (See page 42)
- The actual resolution may differ from the setting in the SETUP menu if both Component and HDMI cables are connected. The resolution may also be different depending on the disc. (See page 42)
- In DVD playback, if both HDMI and Component jacks are connected and you select the Component 1080p, 1080i or 720p mode, the Display Setup menu will show the output resolution as 1080p, 1080i or 720p in the menu. The resolution is actually 480i.



## CONNECTING TO A TV (VIDEO) - GOOD QUALITY

1. Using video/audio cables, connect the **VIDEO (yellow) / AUDIO (red and white) OUT** terminals on the rear of the Blu-ray Disc Player to the **VIDEO (yellow) / AUDIO (red and white) IN** terminals of your TV.
2. Turn on the Blu-ray Disc Player and TV.
3. Press the input selector on your TV remote control until the Video signal from the Blu-ray Disc Player appears on the TV screen.
  - If you have set the remote control to operate your TV (see pages 19~20), press the **TV SOURCE** button on the remote control and select VIDEO as the external source of the TV.

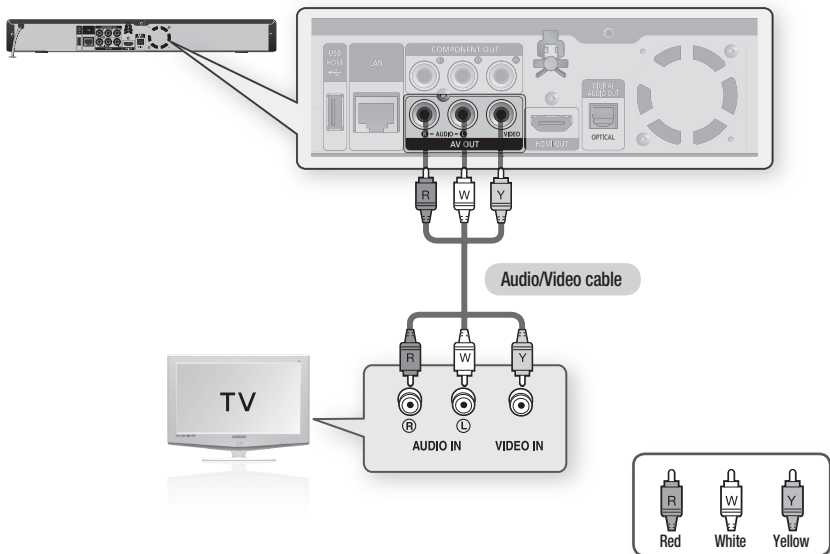

- Noise may be generated if the audio cable is placed too close to the power cable.
- If you want to connect to an Amplifier, please refer to the Amplifier connection pages. (See pages 26~28)
- The number and position of terminals may vary depending on your TV set. Please refer to the user's manual of your TV.
- If there is only one audio input terminal on the TV, connect it to the [AUDIO OUT][left] (white) terminal of the Blu-ray Disc Player.
- The VIDEO source is always output in 480i resolution regardless of the resolution set in the SETUP menu. (See page 42)
- Do not connect the unit through a VCR. Video signals fed through VCRs may be affected by copyright protection systems and the picture will be distorted on the television.

# connections

## CONNECTING TO AN AUDIO SYSTEM (HDMI SUPPORTED AMPLIFIER) - BEST QUALITY (RECOMMENDED)

1. Using an HDMI cable, connect the **HDMI OUT** terminal on the rear of the Blu-ray Disc Player to the **HDMI IN** terminal of your Amplifier.
2. Using an HDMI cable, connect the **HDMI OUT** terminal of the Amplifier to the **HDMI IN** terminal of your TV.
3. Turn on the Blu-ray Disc Player, TV and Amplifier.
4. Press the input select button of the Amplifier to select the **external input** in order to hear sound from the Blu-ray Disc Player. Refer to your Amplifier's user manual to set the Amplifier's audio input.

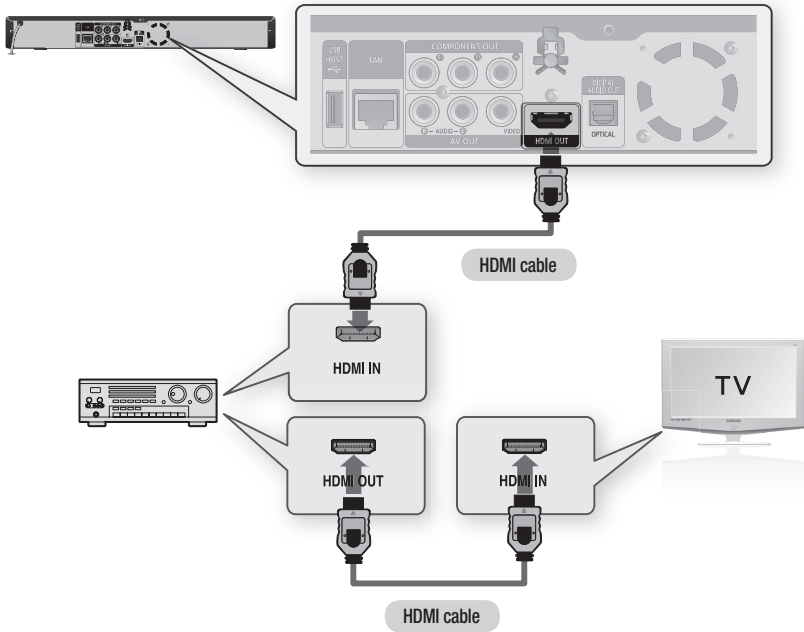

- ☑ Please turn the volume down when you turn on the Amplifier. Sudden loud sound may cause damage to the speakers and your ears.
- Please set the audio in the menu screen according to the Amplifier. (See pages 37~39)
- The position of HDMI terminals may vary depending on the Amplifier. Please refer to the user's manual of your Amplifier.

## CONNECTING TO AN AUDIO SYSTEM (DOLBY DIGITAL, DTS AMPLIFIER) - BETTER QUALITY

1. Using an optical cable (not included), connect the **DIGITAL AUDIO OUT (OPTICAL)** terminal on the rear of the Blu-ray Disc Player to the **DIGITAL AUDIO IN (OPTICAL)** terminal of your Amplifier.
2. Using the video signal cable(s), connect the **HDMI, COMPONENT** or **VIDEO OUT** terminals on the rear of the Blu-ray Disc Player to the **HDMI, COMPONENT** or **VIDEO IN** terminals of your TV. (see pages 21~25)
3. Turn on the Blu-ray Disc Player, TV and Amplifier.
4. Press the input select button of the Amplifier to select the **external input** in order to hear sound from the Blu-ray Disc Player. Refer to your Amplifier's user manual to set the Amplifier's audio input.

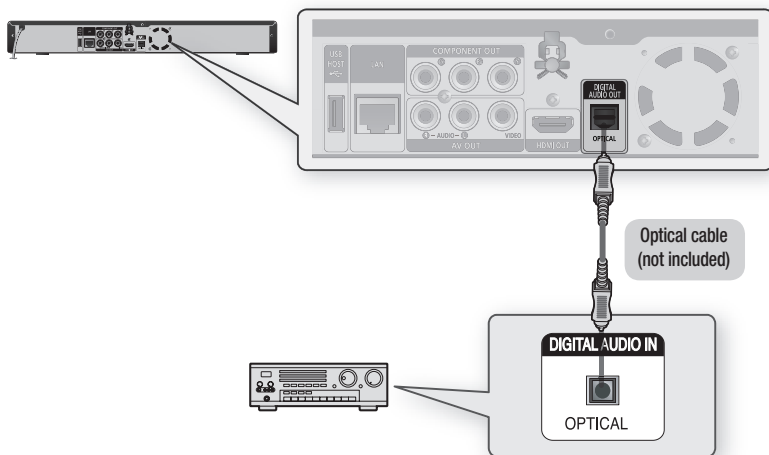

- Please turn the volume down when you turn on the Amplifier. Sudden loud sound may cause damage to the speakers and your ears.
- Please set the audio in the menu screen according to the Amplifier. (See pages 37~39)
- The position of terminals may vary depending on the Amplifier. Please refer to the user's manual of your Amplifier.
- When using this connection, discs with LPCM audio soundtracks will only be heard over the front two channels.

# connections

## CONNECTING TO AN AUDIO SYSTEM (2 CHANNEL AMPLIFIER) - GOOD QUALITY

1. Using the audio cables, connect the **AUDIO (red and white) OUT** terminals on the rear of the Blu-ray Disc Player to the **AUDIO (red and white) IN** terminals of your Amplifier.
2. Using the video signal cable(s), connect the **HDMI, COMPONENT** or **VIDEO OUT** terminals on the rear of the Blu-ray Disc Player to the **HDMI, COMPONENT** or **VIDEO IN** terminal of your TV. (See pages 21~25)
3. Turn on the Blu-ray Disc Player, TV and Amplifier.
4. Press the input select button of the Amplifier to select the **external input** in order to hear sound from the Blu-ray Disc Player. Refer to your Amplifier's user manual to set the Amplifier's audio input.

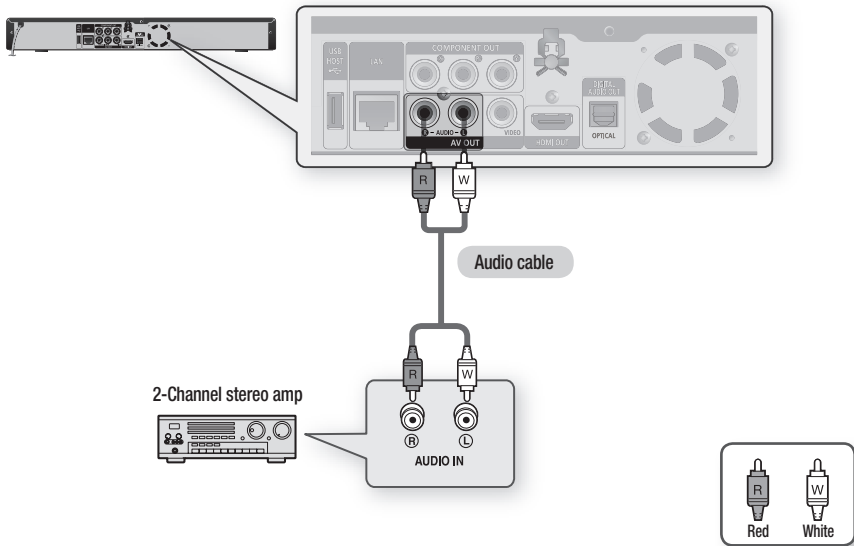

- Manufactured under license from Dolby Laboratories. "Dolby" and the double-D symbol are trademarks of Dolby Laboratories.
- Manufactured under license under U.S. Patent #'s: 5,451,942; 5,956,674; 5,974,380; 5,978,762; 6,226,616; 6,487,535; 7,212,872; 7,333,929; 7,392,195; 7,272,567 & other U.S. and worldwide patents issued & pending. DTS is a registered trademark and the DTS logos, Symbol, DTS-HD and DTS-HD Master Audio are trademarks of DTS, Inc. © 1996-2008 DTS, Inc. All Rights Reserved.

# CONNECTING TO THE NETWORK

To access network service or upgrade the current firmware, you must make one of the following connections.

By connecting to a network, you can access the BD-LIVE, Blockbuster, Netflix, Pandora, YouTube services and Software upgrades from Samsung's update server. We recommend you use an AP or router for the network.

## Cable Network

1. Using the Direct LAN Cable (UTP cable, not included), connect the LAN terminal of the Blu-ray Disc Player to the LAN terminal of your modem.

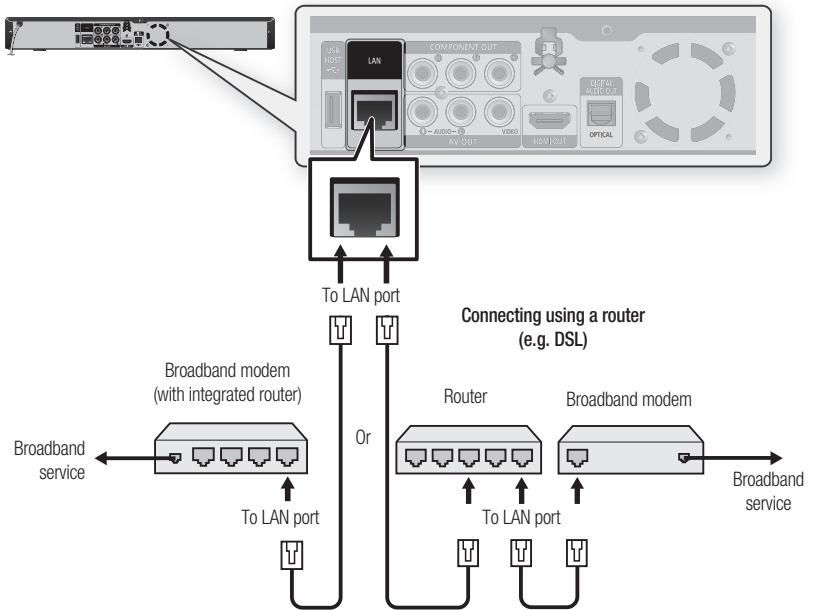

- Set the network options after connecting the LAN cable. (See pages 49~50)
- Internet access to Samsung's update server may not be allowed, depending on the router you use or the ISP's policy.  
For more information, contact your ISP (Internet Service Provider).
- For DSL users, please use a router to make a network connection.

# connections

## Wireless Network

You can connect to network with a Wireless IP sharer.

1. A wireless AP/IP router is required to make a wireless network connection. Connect the wireless LAN adapter to the USB port on the rear panel of the Blu-ray Disc Player, and set the wireless network options. (See pages 50~52)

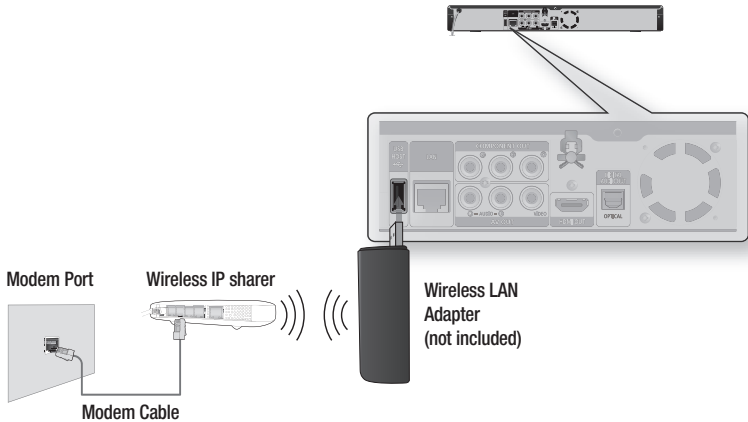

- ☑ This unit is compatible with Samsung's Wireless LAN Adapter only. (not included) (Model name: WIS09ABGN).
  - The Samsung Wireless LAN Adapter is sold separately.
  - Contact a Samsung Electronics agent or service center for purchasing.
- You must use a wireless IP sharer that supports IEEE 802.11 a/b/g/n. (n is recommended for stable operation of the wireless network.)
- Wireless LAN, in its nature, may cause interference, depending on the use condition (AP performance, distance, obstacle, interference by other radio devices, etc).
- Set the wireless IP sharer to Infrastructure mode. Ad-hoc mode is not supported.
- When applying the security key for the AP (wireless IP sharer), only the following is supported.
  - 1) Authentication Mode : WEP, WPAPSK, WPA2PSK
  - 2) Encryption Type : WEP, TKIP, AES

# basic functions of your blu-ray disc player

This section introduces basic playback functions and playback by disc type.

## BEFORE PLAYING

- Turn on your TV and set it to the correct Video Input (the input the Blu-ray Disc Player is connected to).
- If you connected an external Audio System, turn on your Audio System and set it to the correct Audio Input.

After plugging in the player, the first time you press the **POWER** button, this screen comes up:

If you want to select a language, press a **NUMBER** button. (This screen will only appear when you plug in the player for the first time.) If the language for the startup screen is not set, the settings may change whenever you turn the power on or off. Therefore, make sure that you select the language you want to use. Once you select a menu language, you can change it by pressing the **SKIP** (▶▶) button on the front panel of the unit for more than 5 seconds with no disc in the unit. Then the MENU LANGUAGE SELECTION window appears again where you can reset your preferred language.

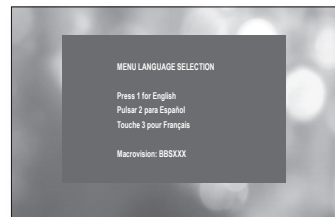

When you connect Blu-ray Disc Player and Samsung TV with Anynet+ feature (HDMI-CEC) using HDMI cable, the MENU LANGUAGE SELECTION window may disappear quickly. If you want to select language, please disable a Anynet+ feature (HDMI-CEC) on your TV.



- Discs which can be played on this player (For the following discs, the ability to play back may depend on recording conditions.)
  - BD-ROM
  - BD-RE
  - BD-R
  - DVD-R
  - DVD-RW (V mode)
  - CD-RW/CD-R
  - The unit may not play certain CD-RW/CD-R and DVD-R due to the disc type or recording conditions.
- Discs which cannot be played on this player.
  - HD DVD
  - DVD+RW/+R
  - DVD-RAM
  - DVD-RW(VR mode)
  - 3.9 GB DVD-R Disc for Authoring.
  - DVD-ROM/PD/MV-Disc, etc
  - Super Audio CD(except CD layer)
  - CVD/CD-ROM/CDV/CD-G/CD-I/LD (CDGs play audio only, not graphics.)
- Blu-ray is a new and evolving format. Accordingly, disc compatibility issues with new and existing format discs are possible. Not all discs are compatible and not every disc will playback. For additional information, refer to the Disc Type and Characteristics and Compliance and Compatibility Notice sections of this Manual. If you encounter compatibility problems, please contact SAMSUNG customer care center.
- The unit cannot play CD-RW/CD-R and DVD-RW/R and USB memory flash stick content such as divx, avi, mpg, mov.

# basic functions of your blu-ray disc player

## ON-SCREEN MENU NAVIGATION

❖ The GUI (Graphical User Interface) in this manual may differ, depending on the firmware version.

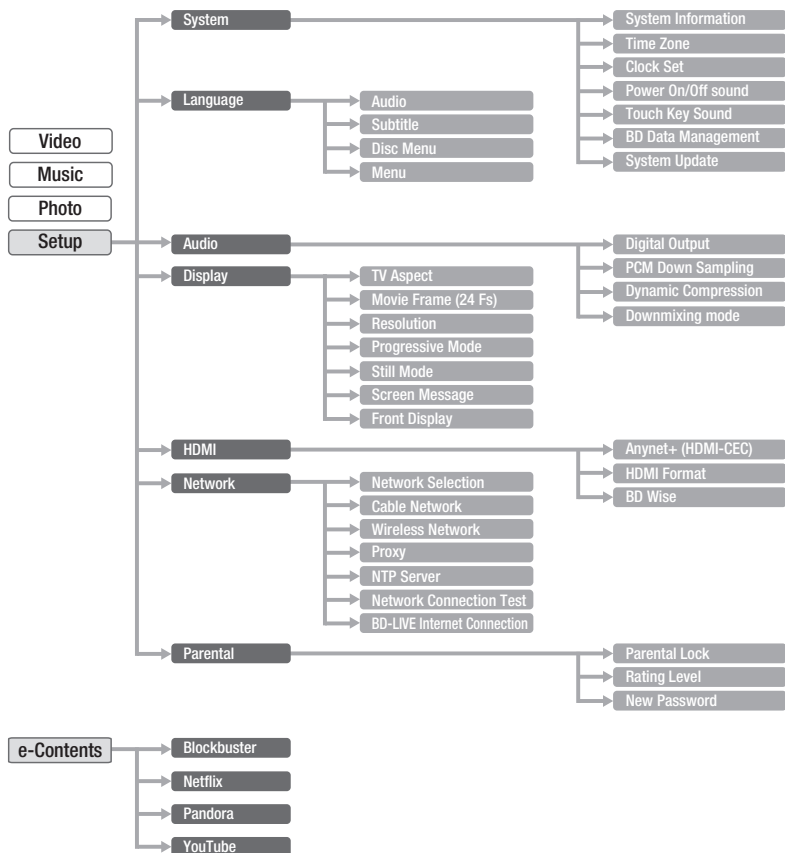



## PLAYING A DISC

1. Press the **OPEN/CLOSE** button.
  2. Place a disc gently into the tray with the disc's label facing up.
  3. Press the **PLAY** button or **OPEN/CLOSE** button to close the disc tray.
-  ■ When you stop disc play, the player remembers where you stopped, so when you press the **PLAY** button again, it will pick up where you left off. This is called the "Resume" function. With some BD discs(BD-J), this function may not work.
- Press the **STOP** button twice during playback to disable the Resume function.
  - To pause the playback, press the **PAUSE** button during playback. To resume, press the **PLAY** button.
  - If the player is left in the stop mode more than 5 minutes without any user interface, a screen saver will appear on your TV. If the player is left in the screen saver mode for more than 15 minutes, the power will automatically turn off except during playback of a CD-DA (Automatic Power-Off Function).
  - If no buttons are pressed on the unit or remote control for more than 5 minutes when the unit is in Pause mode, operation will stop (except for some Blu-ray Discs).

## SETTING THE SOUND

### Setting the Power On / Off Melody Sound

A Melody sound can be set so it is heard each time you turn the player on or off.

1. With the unit in Stop mode, press the **MENU** button.
2. Press the **▲▼** buttons to select **Setup**, then press the **ENTER** or **▶** button.
3. Press the **▲▼** buttons to select **System**, then press the **ENTER** or **▶** button.
4. Press the **▲▼** buttons to select **Power On/Off sound**, then press the **ENTER** or **▶** button.
5. Press the **▲▼** buttons to select **On** or **Off**, then press the **ENTER** or **▶** button.
6. Press the **MENU** button to exit the setup menu.

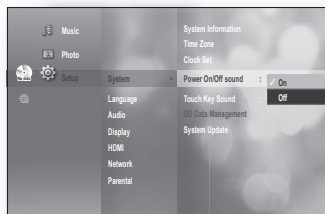

### Setting the Touch Key Sound On / Off

You can set the player so a sound is heard each time a button is pressed on the front panel of the unit. To setup, follow steps 1 through 3 above.

4. Press the **▲▼** buttons to select **Touch Key Sound**, then press the **ENTER** or **▶** button.
5. Press the **▲▼** buttons to select **On** or **Off**, then press the **ENTER** or **▶** button.
6. Press the **MENU** button to exit the setup menu.

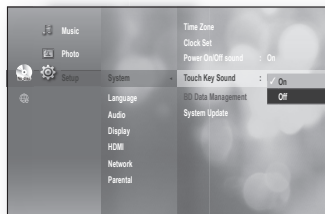

# basic functions of your blu-ray disc player

## USING THE SEARCH AND SKIP FUNCTIONS

During play, you can search quickly through a chapter or track, and use the skip function to jump to the next selection.

### Searching through a Chapter or Track



During playback, press the **SEARCH** ( ) button.

Each time you press the **SEARCH** ( ) button, the playback speed will change as follows.

BD-ROM, BD-RE, BD-R, DVD-VIDEO, DVD-RW, DVD-R	X 2 →  X 4 →  X 8 →  X 16 →  X 32 →  X 128 X 2 →  X 4 →  X 8 →  X 16 →  X 32 →  X 128
--	--

- You can scan the program in reverse.
- To return to normal speed playback, press the **PLAY** button.



- No sound is heard during search mode.

### Skipping Tracks



During playback, press the **SKIP** ( ) button.

When playing a Blu-ray Disc/DVD, if you press the **SKIP** ( ) button, it moves to the next chapter.

If you press the **SKIP** ( ) button, it moves to the beginning of the chapter. One more press makes it move to the beginning of the previous chapter.

## SLOW MOTION PLAY/STEP MOTION PLAY

### Slow Motion Play



In pause mode, press the **SEARCH** ( ) button.

- If you press the **SEARCH** ( ) button, the playback speed is reduced to  
 1/8 1/4 1/2
- To return to normal speed playback, press the **PLAY** button.



- This ( ) icon indicates an invalid button press.
- No sound is heard during slow mode.
- Slow motion operates only in the forward direction.

### Step Motion Play



In pause mode, press the **PAUSE** button.

- Each time the **PAUSE** button is pressed a new frame will appear.
- To return to normal speed playback, press the **PLAY** button.



- No sound is heard during step mode.
- Step motion operates only in the forward direction.

# system setup

For your convenience, you can set this player's features for the best use in your home environment.

## SETTING THE CLOCK

### Choose your time zone

1. With the unit in Stop mode, press the **MENU** button.
2. Press the **▲▼** buttons to select **Setup**, then press the **ENTER** or **▶** button.
3. Press the **▲▼** buttons to select **System**, then press the **ENTER** or **▶** button.
4. Press the **▲▼** buttons to select **Time Zone**, then press the **ENTER** or **▶** button.
5. Use the **◀▶** button to place the cursor to the appropriate time zone for your area and press the **ENTER** button.

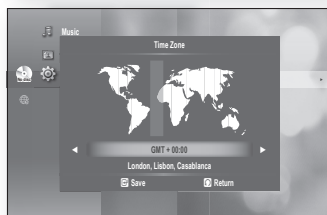
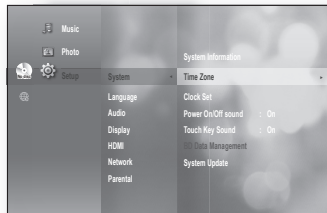

■ To set the time automatically, set the NTP server to **On** (see page 53).

### Set the clock

To setup, follow steps 1 through 3 above.

4. Press the **▲▼** buttons to select **Clock Set**, then press the **ENTER** or **▶** button.
5. Press the **◀▶** buttons to move to "**Date**", "**hr.**" (hour), "**min.**" (minute) and "**am/pm**". Set the date and time by pressing the **▲▼** buttons, then press the **ENTER** button.

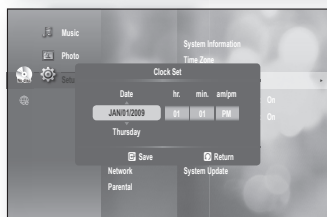
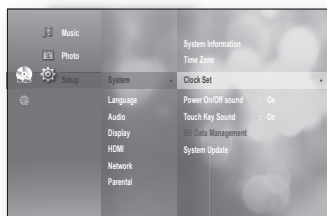

# language setup

## SETTING UP THE LANGUAGE OPTIONS

Once you set the audio, subtitle, disc menu and player menu language options, they will be applied automatically every time you watch a movie.

- ✍ If you want to choose a different audio and subtitle language while playing a disc, you can also use the disc menu to make the selection.

1. With the unit in Stop mode, press the **MENU** button.
2. Press the **▲▼** buttons to select **Setup**, then press the **ENTER** or **▶** button.

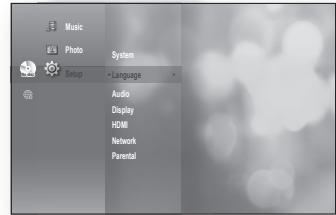

3. Press the **▲▼** buttons to select **Language**, then press the **ENTER** or **▶** button.  
Language Setup menu will be displayed.

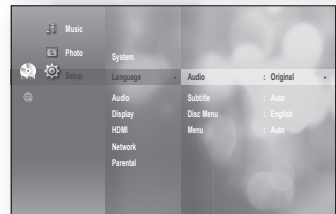

4. Press the **▲▼** buttons to select the desired language option, press the **ENTER** or **▶** button.

- **Audio** : For the disc audio language.
- **Subtitle** : For the disc subtitles.
- **Disc Menu** : For the disc menu contained on the disc
- **Menu** : For the on-screen menu of your Blu-ray Disc Player.

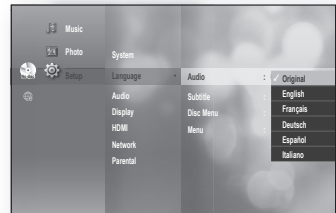

5. Press the **▲▼** buttons to select the desired language, then press the **ENTER** button.

- ✍ Press the **RETURN** or **◀** button to return to the previous menu. Press the **MENU** button to exit the menu.
- The selected language will only appear if it is supported on the disc.

# audio setup

## SETTING UP THE AUDIO OPTIONS

Allows you to set up the Audio device and sound status depending on the audio system being used with the player.

1. With the unit in Stop mode, press the **MENU** button.
2. Press the **▲▼** buttons to select **Setup**, then press the **ENTER** or **▶** button.
3. Press the **▲▼** buttons to select **Audio**, then press the **ENTER** or **▶** button.
4. Press the **▲▼** buttons to select the desired audio option from the options described below, then press the **ENTER** or **▶** button.
5. Press the **▲▼** buttons to select the desired item, then press the **ENTER** button.
6. Each audio option is described in detail below.



Press the **RETURN** or **◀** button to return to the previous menu. Press the **MENU** button to exit the menu.

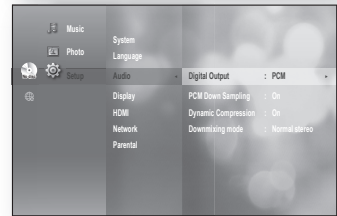
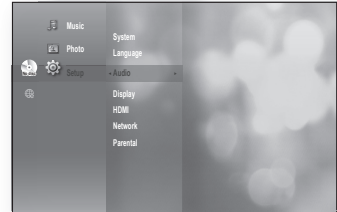

### Digital Output

Blu-ray Discs may include three audio streams.

- Primary Audio : Main audio soundtrack of the disc
- Secondary Audio : Provides audio for the BONUSVIEW window of a Blu-ray Disc.
- Effect Audio : You may hear menu prompt sounds (etc.) when selecting menu items on a Blu-ray Disc (depending on the disc).

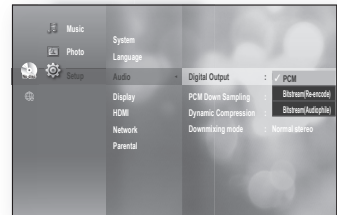

### Digital Output Selections

Setup	Definition	Pro	Con	Recommended use
PCM	Decodes Primary, Secondary and Effect audio streams together into PCM audio.	You can enjoy not only Primary audio but also Secondary and Effect audio together. This unit can decode Dolby TrueHD and DTS-HD Master Audio, the output audio quality will be same with Bitstream (audiophile) setup.	If you are using an optical cable, you may not hear multichannel surround audio.	Recommended choice if you have an HDMI receiver.
Bitstream (Re-encode)	Decodes Primary, Secondary and Effect audio streams together into PCM audio, then re-encodes the PCM audio into DTS bitstream.	You can enjoy not only Primary audio, but also Secondary and Effect audio together.	Audio quality may be lower than PCM or Bitstream (Audiophile) setups when you are using a receiver with HDMI or Optical input.	Recommended choice if you don't have an HDMI supported receiver, but have a receiver with an Optical input that can decode DTS.
Bitstream (Audiophile)	Outputs only the Primary audio soundtrack (main soundtrack of the main feature) so that your receiver can decode the audio bitstream.	This unit can decode Dolby TrueHD and DTS-HD Master Audio, the output audio quality will be same with PCM setup.	You will not hear Secondary and Effect audio.	Recommended choice if you have an HDMI 1.3 receiver which has Dolby TrueHD and DTS-HD Master Audio decoding capability.

# audio setup

- ☑ Be sure to select the correct Digital Output or you will hear no sound or a loud noise.
- ☑ If the HDMI device (Receiver, TV) is not compatible with compressed formats (Dolby digital, DTS), the audio signal outputs as PCM.
- ☑ Secondary and Effect audio will not be heard with regular DVDs.
- ☑ Some Blu-ray Discs do not have Secondary and Effect audio.
- ☑ This Digital Output setup does not effect the analog (L/R) audio or HDMI audio output to your TV. It effects the optical and HDMI audio output when connected to a receiver.
- ☑ When the player outputs HD audio bitstream(Dolby TrueHD or DTS-HD Master Audio) from the Optical jack to an HDMI 1.3 receiver, only 2 channel PCM audio will be heard.
- ☑ If you play MPEG audio soundtracks, audio signal outputs PCM regardless of Digital Output Selections(PCM or Bitstream).

## PCM Down Sampling

- **On** : Select this when the Amplifier connected to the player is not 96KHz compatible. 96KHz signals will be down converted to 48KHz
- **Off** : Select this when the Amplifier connected to the player is 96KHz compatible. Signals will be output without any changes.

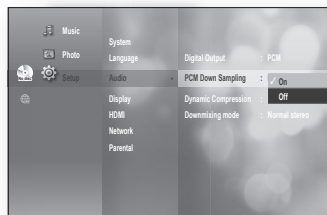

- ☑ Even when PCM Down Sampling is set to **Off**, some discs will only output downsampled audio through the optical digital outputs.

## HDMI

- If your TV is not compatible with compressed multi-channel formats (Dolby Digital, DTS), the unit may output PCM 2ch downmixed audio even though you set Bitstream(either Re-encode or Audiophile) on your setup menu.
- If your TV is not compatible with PCM sampling rates over 48kHz, the unit may output 48kHz downsampled PCM audio even though you set "PCM Down Sampling" to **Off**.

## Dynamic Compression

This is only active when a Dolby Digital signal is detected.

- **On** : When Movie soundtracks are played at low volume or from smaller speakers, the system can apply appropriate compression to make low-level content more intelligible and prevent dramatic passages from getting too loud.
- **Off** : You can enjoy the movie with the standard Dynamic Range.

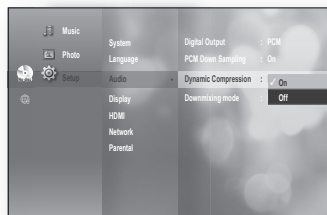

## Downmixing mode

This option enable you to compatible with Dolby Pro Logic systems.

- **Normal stereo** : This is for just downmixing into 2ch audio.It is not compatible with Dolby Surround or Dolby Surround Pro Logic or Dolby Pro Logic II.
- **Surround Compatible** : The 2/0 Lt/Rt downmix is a two-channel Dolby Surround compatible output that can be decoded by Dolby Surround (passive), Dolby Surround Pro Logic (active) or Dolby Pro Logic II (active) decoders. This downmix provides backward compatibility with existing Dolby Surround systems and can be recorded on two-channel media such as the videotape used by videocassette recorders.

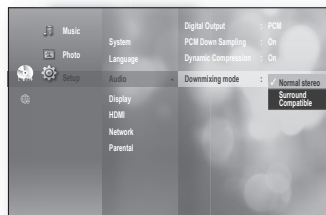

# display setup

## SETTING UP THE DISPLAY OPTIONS

This function allows you to setup the TV screen settings. This function depends on the disc or TV type. It may not work with some discs or TVs.

1. With the unit in Stop mode, press the **MENU** button.
2. Press the **▲▼** buttons to select **Setup**, then press the **ENTER** or **▶** button.
3. Press the **▲▼** buttons to select **Display**, then press the **ENTER** or **▶** button.  
Display Setup menu will be displayed.
4. Press the **▲▼** buttons to select the desired display option from the options on the following pages.
5. Press the **▲▼** buttons to select the desired sub-menu item from a video display option, then press the **ENTER** button.
6. Each video option is described in detail below.

-  Press the **RETURN** or **◀** button to return to the previous menu. Press the **MENU** button to exit the menu.

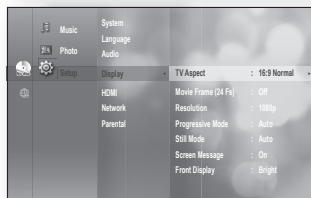
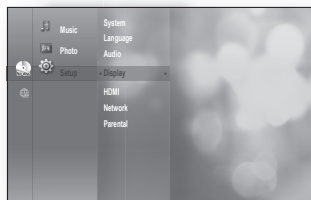

## TV Aspect

Depending on the type of television you have, you may want to adjust the screen setting. (aspect ratio)



### • 4:3 Letter Box :

Select when you want to see the total 16:9 ratio screen Blu-ray Disc/DVD supplies, even though you have a TV with a 4:3 ratio screen. Black bars will appear at the top and bottom of the screen.



### • 4:3 Pan-Scan :

Select when you want to see the 16:9 video supplied by the Blu-ray Disc/DVD without the black bars on top and bottom, even though you have a TV with a 4:3 ratio screen (extreme left and right portion of the movie picture will be cut off).



### • 16:9 Wide :

You can view the full 16:9 picture on your widescreen TV.



### • 16:9 Normal :

Certain movies (4:3 source) will be displayed in 4:3 Pillarbox (black bars on sides of picture) if 16:9 normal is selected.

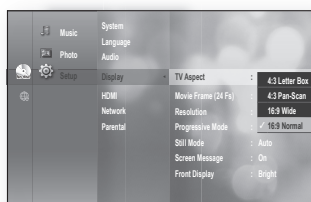

-  Depending on the disc type, some aspect ratios may not be available.
- If you select an aspect ratio which is different than the aspect ratio of your TV screen, then the picture might appear to be distorted.



## Movie Frame (24 Fs)

Movies are usually filmed at 24 frames per second. Some Blu-ray Discs have the capability of playing back at this frame rate. Setting the Movie Frame (24Fs) feature to ON allows you to adjust the Blu-ray Disc Player's HDMI output to 24 frames per second for improved picture quality.

You can enjoy the Movie Frame (24Fs) feature only on a TV supporting this frame rate.

This menu can only be selected in 1080i or 1080p HDMI output resolution modes.

Depending on the disc, two types of frame rates may be included: Movie material (24 frame) and Video material (30 frame). When the setting switches between Movie (24 frame) and Video (30 frame), the screen may blink for a few seconds.

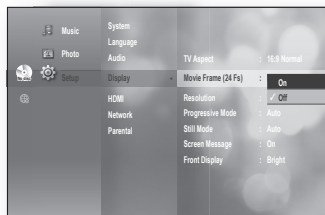

## Resolution

Sets the output resolution of the Component and HDMI video signal.

- The number in 480i, 480p, 720p, 1080p and 1080i indicates the number of lines of video. The i and p indicate interlace and progressive scan, respectively.
  - BD Wise : Automatically sets the optimal resolution when connected via HDMI to a TV with the BD Wise feature.  
(The BD Wise menu item appears only if BD Wise is set to On.)
  - 1080p : Outputs 1080 lines of progressive video (HDMI only).
  - 1080i : Outputs 1080 lines of interlaced video.
  - 720p : Outputs 720 lines of progressive video.
  - 480p : Outputs 480 lines of progressive video.
  - 480i : Outputs 480 lines of interlaced video (Component only).

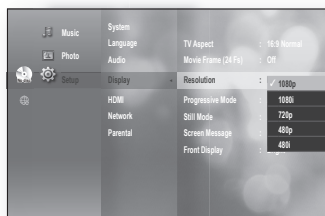

If the connected TV does not support Movie Frame or the selected resolution, you will see the following message:

If you select **Yes** and the resolution is not supported, the TV's screen will be blank. Please wait for 15 seconds and the resolution will be reverted to the previous value automatically.

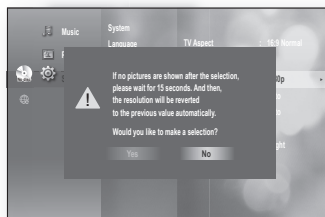

- If the screen is blank, press and hold the **SKIP** (▶▶) button on the front of the player for more than 5 seconds (no disc inserted). All settings are restored to the factory default. Follow the steps on the previous page to access each mode and select the Display Setup that your TV will support.
- When the factory default settings are restored, all the user data stored in the BD data will be deleted.

# display setup

## ❖ Resolution according to the output mode

### • Blu-ray Disc playback

Setup \ Output	HDMI	Component (HDMI&Comp. connected / Comp. connected only)	VIDEO
1080p, Movie Frame(24Fs) off	1080p@60F	1080i	480i
1080p/1080i, Movie Frame (24Fs) on	1080p@24F	480i / 1080i	480i
1080i, Movie Frame (24Fs) off	1080i	1080i	480i
720p	720p	720p	480i
480p	480p	480p	480i
480i	480p	480i	480i

### • DVD playback

Setup \ Output	HDMI	Component (HDMI&Comp. connected / Comp. connected only)	VIDEO
1080p	1080p@60F	480i / 480p	480i
1080i	1080i	480i / 480p	480i
720p	720p	480i / 480p	480i
480p	480p	480i / 480p	480i
480i	480p	480i	480i



- In DVD playback, if both HDMI and Component jacks are connected and you select the Component 1080p, 1080i or 720p mode, the Display Setup menu will show the output resolution as 1080p, 1080i or 720p in the menu.  
The resolution is actually 480i.
- This player has the HDMI Auto Detect Feature. When the player is first connected to a TV via HDMI, the player's output will be set automatically to HDMI.
- If the HDMI Auto Detection feature does not work, you can't select the 1080p resolution or Movie Frame (24Fs).
- The Blu-ray Disc must have the 24 frame feature in order to use the Movie Frame (24Fs) mode.

## Progressive Mode

The Progressive Mode helps to improve picture quality when viewing 480i resolution DVD discs.

- **Auto** : Select this to have the player automatically set the best picture for the DVD you're watching.
- **Video** : Select this for the best picture from Concert or TV show DVDs.



## Frame & Field bar

### Still Mode

Set the Auto, Field or Frame setting for the best possible still picture (pause mode) from a DVD.

- **Auto** : Select this setting to have the player automatically display the best Still picture depending on the content.
- **Field Mode** : Select this when pausing a scene with a lot of action.
- **Frame Mode** : Select this to increase the resolution of the Still picture.

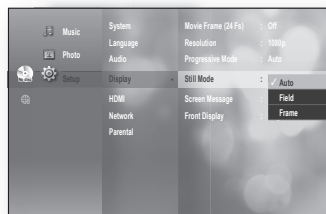

### Screen Message

- **On** : Displays messages related to operation mode.
- **Off** : Does not display messages related to operation mode.

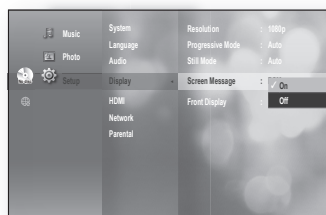

### Front Display

- **Auto** : Display is dim during playback and bright when the unit is in Stop mode.
- **Dim** : Select to dim the display window.
- **Bright** : Select to brighten the display window.

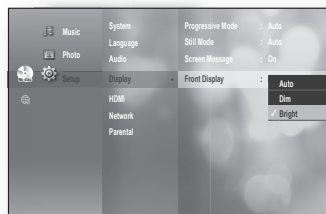

# HDMI setup

## SETTING UP THE HDMI SETUP OPTIONS

1. With the unit in Stop mode, press the **MENU** button.
2. Press the **▲▼** buttons to select **Setup**, then press the **ENTER** or **▶** button.
3. Press the **▲▼** buttons to select **HDMI**, then press the **ENTER** or **▶** button.  
HDMI Setup menu will be displayed.
4. Press the **▲▼** buttons to select the desired display option, then press the **ENTER** or **▶** button.

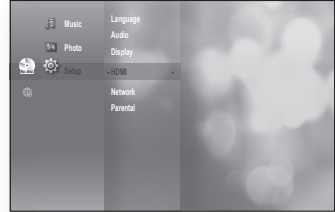

## Anynet+ (HDMI-CEC) (Samsung products only)

When HDMI is set to on, you can operate the Anynet+ function.

- **On** : Anynet+ functions will work.
- **Off** : Anynet+ function will not work.

### What is Anynet+?

Anynet+ is a convenient function that offers linked operations with other Samsung products with the Anynet+ feature.

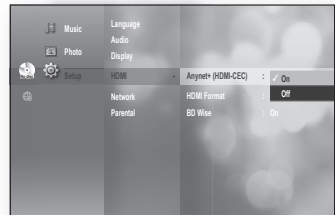

You can operate this unit using a Samsung TV remote control or power on your Samsung TV and Home theater and start disc playback simply by pressing the **PLAY** button on the TV's remote.



- This function is not available if the HDMI cable does not support CEC.

### To use Anynet+

1. Connect the **Blu-ray Disc Player** to a Samsung TV with an HDMI cable. (See pages 21~23)
2. Set the Anynet+ (HDMI-CEC) to "On" on your **Blu-ray Disc Player**.
3. Set the Anynet+ function on your TV. (See the TV instruction manual for more information.)

### Anynet+ Functions

- One touch play  
You can power on your Samsung TV and Home Theater, and play the disc in this unit simply by pressing the **PLAY** button on the TV's remote.
- One touch watching  
Select "Watching Blu-ray Disc Player" or "Connected to Blu-ray Disc Player" (depending on your TV's menu) in the Anynet+ menu on the TV. The Blu-ray Disc Player will automatically turn on and the TV will be switched to HDMI mode.
- Remote control Link  
You can operate this player with your Samsung TV remote control.
- Available buttons on the Samsung TV remote: These buttons work the same as this Blu-ray Disc player's remote control.

- Playback control buttons :

- Menu operation button :

- Numeric buttons :

- Color buttons :

### TV Anynet+ Menu

When you press the Anynet+ button on your Samsung TV's remote control, the following On-Screen Display (OSD) will be shown.



- Blu-ray Disc Player Menu
  - When playing a movie : brings up the disc's menu (same as **DISC MENU** button on the Blu-ray Disc Player's remote control)
  - In Stop mode : brings up the SETUP menu (same as the **MENU** button on the Blu-ray Disc Player's remote control.)
- Blu-ray Disc Player Operation Menu
  - When playing a DVD VIDEO, DVD-RW/-R, BD-ROM, BD-RE : shows INFO OSD (same as **INFO** button on the player's remote control)

 These menus may look different depending on your Samsung TV.

### HDMI Format

You can optimize the HDMI output for connection to a TV or Monitor.

- **TV** : Select if connected to a TV via HDMI.
- **Monitor** : Select if connected to a Monitor via HDMI.  
If the player is connected to a TV, the Monitor option is unavailable.

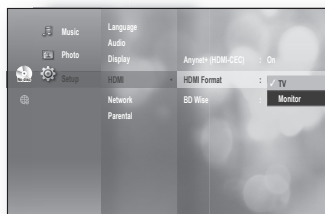

 TV or monitor has to be connected to the player before you select this option.

# HDMI setup

## BD Wise (Samsung products only)

BD Wise is Samsung's latest inter-connectivity feature.

When you connect Samsung products with BD-Wise to each other via HDMI, the optimum resolution will be set automatically.

- **On** : The original resolution of the BD/DVD disc will be output to the TV directly.
- **Off** : The output resolution will be fixed according to the Resolution previously set, regardless of the resolution of the disc.

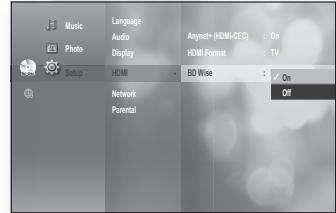

- ✍️ If you want to change the resolution in BD Wise, you must set BD Wise to **Off** in advance.
- If you set off the BD Wise, the resolution of the connected TV will be adjusted to its maximum resolution automatically.
- If the player is connected to a device that does not support BD Wise, you can not use BD wise function.
- For a proper operation of BD Wise, set each BD Wise menu of the player and the TV to **On** respectively.

# parental setup

## SETTING UP THE PARENTAL LOCK

The Parental Lock function works in conjunction with Blu-ray Disc/DVDs that have been assigned a rating which helps you control the types of Blu-ray Disc/DVDs that your family watches. There are up to 8 rating levels on a disc.



1. With the unit in Stop mode, press the **MENU** button.
2. Press the **▲▼** buttons to select **Setup**, then press the **ENTER** or **▶** button.

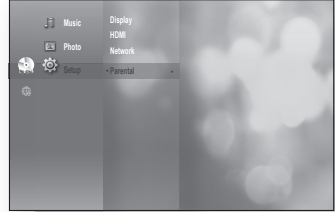

3. Press the **▲▼** buttons to select **Parental**, then press the **ENTER** or **▶** button.  
When you operate your Blu-ray Disc Player for the first time, the "Enter New password." message will be displayed.

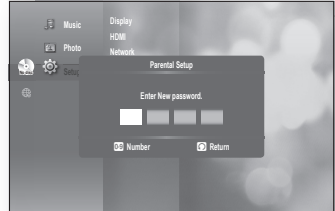

4. Enter the 4-digit password using the number buttons on the remote control.  
The "Confirm the password." message will be displayed.  
Enter your password again.



5. Press the **ENTER** or **▶** button to select **Parental Lock**.
6. Press the **▲▼** buttons to select **On** or **Off**, then press the **ENTER** button.

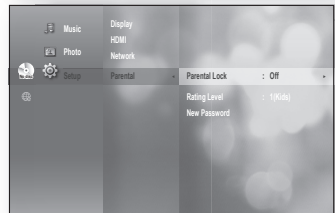

Press the **RETURN** or **◀** button to return to the previous menu. Press the **MENU** button to exit the menu.

# parental setup

## If you forgot your password

1. Remove the disc.
2. Press and hold the **SKIP** (▶) button on the front panel for 5 seconds or more.
  - All settings will revert to the factory settings.



When the factory default settings are restored, all the user data stored in the BD data will be deleted.

## Setting the Rating Level

1. Press the ▲▼ buttons to select **Rating Level**, then press the **ENTER** or ► button.
2. Press the ▲▼ buttons to select the rating level you want, then press the **ENTER** button. For example, if you select up to Level 6, discs that contain Level 7, 8 will not play.

A larger number indicates that the program is intended for adult use only.  
Level 1 is the most restrictive and Level 8 is the least.

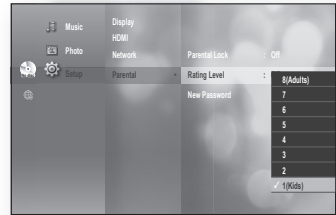

## Changing the Password

1. Press the ▲▼ buttons to select **New Password**, then press the **ENTER** or ► button.
2. Enter the 4-digit password using the number buttons on the remote control. The “Enter New password.” message will be displayed.
3. Enter your password again using the number buttons on the remote control.

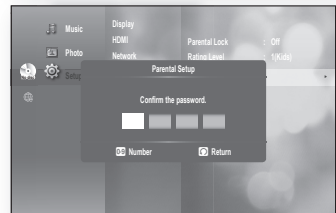
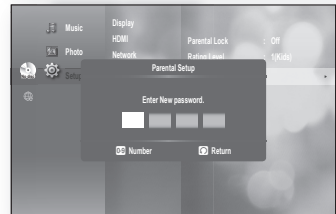
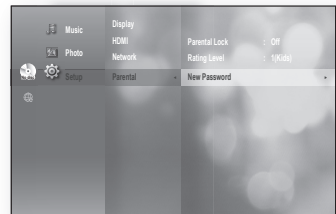



# network setup

## SETTING UP THE NETWORK SETUP OPTIONS

To obtain information on the proper settings, check the network settings on your computer or contact your Internet provider.

To set the network of your Blu-ray Disc player, follow the steps below.

1. With the unit in Stop mode/No Disc mode, press the **MENU** button.
2. Press the **▲▼** buttons to select **Setup**, then press the **ENTER** or **▶** button.
3. Press the **▲▼** buttons to select **Network**, then press the **ENTER** or **▶** button.
4. Press the **▲▼** buttons to select the desired network option from the options described below, then press the **ENTER** or **▶** button.
5. Press the **▲▼** buttons to select the desired item, then press the **ENTER** button.  
Each network option is described in detail below.

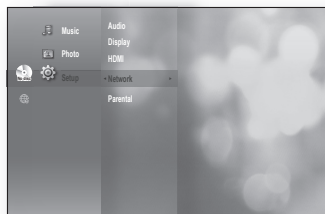

### Network Selection

Select Cable or Wireless as the method to connect to network.

To setup, follow steps 1~3 on page 49.

4. Press the **▲▼** buttons to select **Network Selection**, then press the **ENTER** or **▶** button.
  - **Cable** : Select this to connect to the network using a cable. (see page 29)
  - **Wireless** : Select this to connect to the network wirelessly. (see page 30)

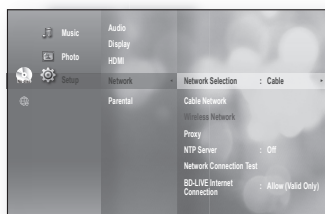

### Cable Network

To setup, follow steps 1~3 on page 49.

4. Press the **▲▼** buttons to select **Cable Network**, then press the **ENTER** or **▶** button.
5. Press the **▲▼** buttons to select **DHCP**, then press the **ENTER** button.



- If DHCP is set to **On**, you can't select IP Address, Subnet Mask or Gateway.
- If DNS is set to **Auto**, you can't select Primary/ Secondary DNS.

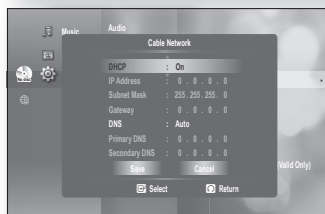
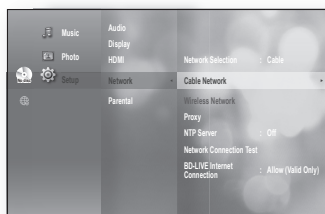

# network setup

6. Press the ▲▼ buttons to select a desired item, then press the **ENTER** button.

- If DHCP is set to **Off** and, DNS to Manual, enter your IP Address, Subnet Mask, Gateway and Primary DNS settings (Secondary DNS is optional).

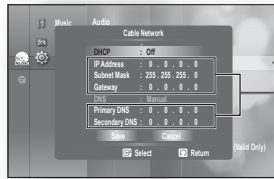

Setup available

- If DHCP is set to **On** and, DNS to Manual, enter your Primary DNS setting (Secondary DNS is optional).

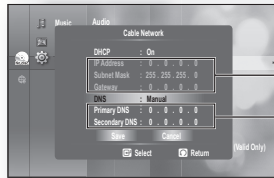

Setup not available

Setup available

- If DHCP is set to **On** and, DNS to Auto, you don't need further or additional settings.

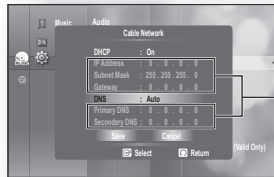

Setup not available

- ✍️ When you select an item, use the number and ▲▼◀▶ buttons.
- If the automatic settings don't work, contact your ISP.

7. When done, use the ▲▼ buttons to select **Save**, then press the **ENTER** button.

8. If you don't want to save your work, use the ▲▼◀▶ buttons to select **Cancel**, then press the **ENTER** button.

- ✍️ The IP address used in this manual is for illustrative purposes only. You must refer to your network settings for the actual IP address.
- To obtain settings for IP address, Subnet mask, Gateway and Primary DNS, check the network settings in your computer or contact your internet service provider.

## Wireless Network

To setup, follow steps 1~3 on page 49.

4. Press the ▲▼ buttons to select **Wireless Network**, then press the **ENTER** or ▶ button.

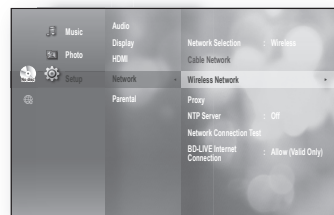

5. Press the ▲▼ buttons to select **DHCP**, then press the **ENTER** button.



- If DHCP is set to **On**, you can't select IP Address, Subnet Mask or Gateway.
- If DNS is set to **Auto**, you can't select Primary/ Secondary DNS.

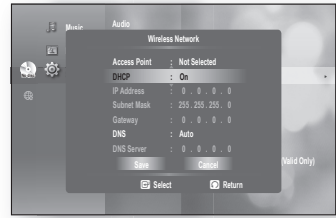

6. Press the ▲▼ buttons to select a desired item, then press the **ENTER** button.

- Select an Access Point, and then press the **ENTER** button to display an available list of APs. (It may take several seconds to search.)
  - When you select an AP and press the **ENTER** button, it tries to connect to the designated AP.
  - If successful, a notification appears. (If selected AP shows a Lock icon, you may need to provide security authentication.)

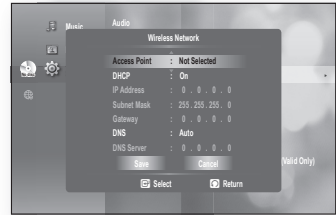

- Select your appropriate Security Access Point if it is known. If it is not, select WEP, WPA2PSK or WPA2PSK from the list below and enter in the password. Keep trying each Security Access Point and enter the Password until a connection is made.

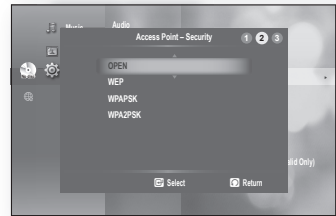

- Enter in the Password then press the **BLUE (D)** button to connect to your access point (Router).

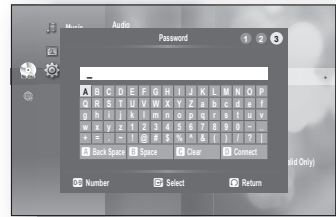

For further details on AP security, refer to the AP's (Router) user manual.

- If DHCP is set to **Off** and, DNS to Manual, enter your IP Address, Subnet Mask, Gateway and DNS Server.

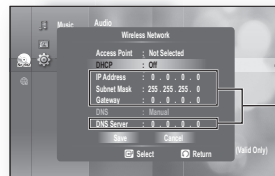

Setup available

# network setup

- If DHCP is set to **On** and, DNS to Manual, enter your DNS Server.

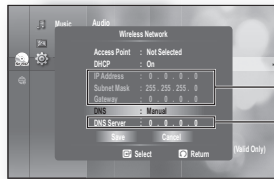

- If DHCP is set to **On** and, DNS to Auto, you don't need further or additional settings.

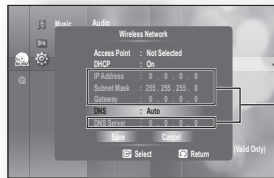

- ☑ ▪ When you select an item, use the number and ▲▼◀▶ buttons.
- If the automatic settings don't work, contact your ISP.

7. When done, use the ▲▼ buttons to select **Save**, then press the ENTER button.

8. If you don't want to save your work, use the ▲▼◀▶ buttons to select **Cancel**, then press the ENTER button.

- ☑ ▪ The IP address used in this manual is for illustrative purposes only. You must refer to your network settings for the actual IP address.
- To obtain settings for IP address, Subnet mask, Gateway and DNS Server, check the network settings in your computer or contact your internet service provider.

## Proxy Setting

A proxy server services requests by forwarding them to other servers.

If you are required to configure the proxy setting, enter the settings specified by the ISP.

To setup, follow steps 1~3 on page 49.

4. Press the ▲▼ buttons to select **Proxy**, then press the ENTER or ▶ button.

- **Server**
- **Port**
- **User**
- **Password**



- ☑ ▪ For more information, contact your ISP (Internet Service Provider).

## NTP Server (Used to Retrieve Time Information from NTP Server)

To setup, follow steps 1~3 on page 49.

4. Press the ▲▼ buttons to select **NTP Server**, then press the **ENTER** or ► button.
  - **On** : The player automatically connects to the Internet server in order to adjust the time setting.
  - **Off** : The player does not connect to the Internet server to adjust the time setting.

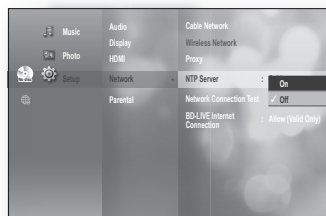

## Network Connection Test

Use this menu to check whether your network connection is working or not.

To setup, follow steps 1~3 on page 49.

4. Press the ▲▼ buttons to select **Network Connection Test**, then press the **ENTER** or ► button.

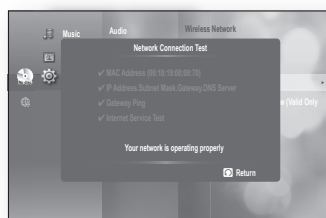

## BD-LIVE Internet Connection

The Blu-ray Disc player supports BD-LIVE which enables you to enjoy a variety of interactive service contents provided by the disc manufacturer through a network connection. To enjoy this feature, you must first perform the LAN connection (see page 29) or Wireless LAN adapter connection to the USB slot.

\* You must have a minimum 1 GB USB Memory device inserted in one of the USB slots in order to download content from BD-LIVE.

The Internet connection may be restricted while you are using BD-LIVE contents.

To setup, follow steps 1~3 on page 49.

4. Press the ▲▼ buttons to select **BD-LIVE Internet Connection**, then press the **ENTER** or ► button.
  - **Allow (All)** : The Internet connection will be allowed for all BD-LIVE contents.
  - **Allow (Valid Only)** : The Internet connection will be allowed only for BD-LIVE contents containing a valid certificate.
  - **Prohibit** : No Internet connection will be allowed for any BD-LIVE content.

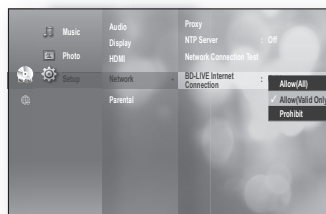

- **What is a valid certificate?** When the Blu-ray Disc player uses BD-LIVE to send the disc data and request to the server to certify the disc, the server uses the transferred data to check if the disc is valid and sends the certificate back to the player.
  - The Internet connection may be restricted while you are using BD-LIVE contents.

# BD data management

BD Data (stored in external USB flash memory) is Blu-ray Disc content such as trailers and other special features downloaded from the BD-LIVE service or Blu-ray Discs.

\* You must have a minimum 1GB USB Memory device inserted in one of the USB slots in order to download content from BD-LIVE.

## SYSTEM DEVICE MANAGEMENT

You can manage user data stored in BD data.

1. With the unit in Stop mode, press the **MENU** button.
2. Press the **▲▼** buttons to select **Setup**, then press the **ENTER** or **▶** button.
3. Press the **▲▼** buttons to select **System**, then press the **ENTER** or **▶** button.
4. Press the **▲▼** buttons to select **BD Data Management**, then press the **ENTER** or **▶** button.

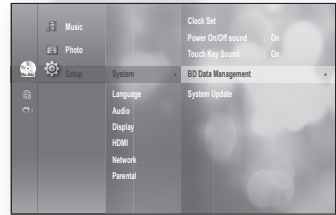

### - To delete the flash memory -

1. Press the **ENTER** button to select **BD Data Delete**.  
The message "All BD data will be deleted. Do you want to continue?" will be displayed.
2. Press the **◀▶** button to select **Yes**, then press the **ENTER** button.

### Description of Device(Storage) Information on the Player

- Total Size : Total size of the Device(Storage).
- Available Size : Available size of the Device(Storage).

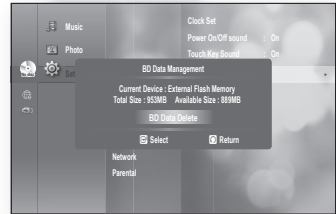

- In the external memory mode, disc playback will be stopped if you disconnect the USB device in the middle of the playback.
- Only those USB devices formatted in FAT file system (DOS 8.3 volume label) are supported, and it is recommended to use USB devices that support USB 2.0 protocol, 4 MB/sec or faster read/write speed.
- The Resume Play function may not work after formatting the storage device.
- The total size of BD Data Management may differ, depending on the firmware version.

# system upgrade

Samsung may offer upgrades to your Blu-ray Disc Player's firmware in the future. To upgrade this firmware you must :

1. USB : Visit [www.samsung.com/bluraysupport](http://www.samsung.com/bluraysupport), then download and store the latest firmware (RUF file) into the USB flash drive. Connect the USB flash drive to the USB port of Blu-ray Disc Player (disc tray must be empty) to update the firmware, then follow the on-screen instructions.
2. CD/DVD : Visit [www.samsung.com/bluraysupport](http://www.samsung.com/bluraysupport), download and write the latest firmware (RUF file) onto a disc. Insert and play the disc in the Blu-ray Disc Player to start the update, then follow the on-screen instructions.
3. Ethernet : If the Blu-ray Disc Player is properly connected to the network by cable or wirelessly, the Blu-ray Disc Player will automatically connect to our website each time it is turned on and download update files if any valid upgrade exists. follow the steps below.

## FIRMWARE UPGRADE

1. With the unit in Stop mode/No Disc mode, press the **MENU** button.
2. Press the **▲▼** buttons to select **Setup**, then press the **ENTER** or **▶** button.
3. Press the **▲▼** buttons to select **System**, then press the **ENTER** or **▶** button.
4. Press the **▲▼** buttons to select **System Update**, then press the **ENTER** or **▶** button.

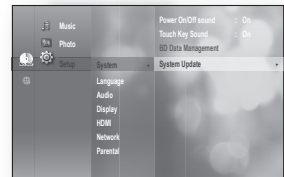

5. The player will check the cable or network connection status automatically. The connection checking window will be displayed.

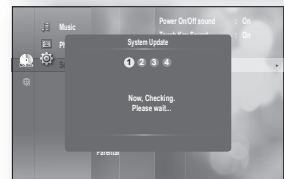

- If the upgrade is possible : You will see information on the current and new versions of firmware in a message box.
- If the upgrade is not possible : You will see the following description in the message box.

- If the cable is not connected :  
"Ethernet cable is not connected. Please, check the Ethernet cable"
- If the network connection has failed :  
"This system can not connect to internet for update. Please, check the network setup"
- If no latest version is released (the latest version has been already installed) :  
"The latest version of the firmware is already installed. There is no need to update."



# system upgrade

- If there is a disc in the player :  
"Please maintain "No Disc" state for network update."  
This indicates that you must remove all discs from the unit to perform the update.
  - If the server service is not available :  
" Update Server is under maintenance. Please try again later."
6. To perform the system upgrade, press the ◀ ▶ buttons to select **Start** and then press the **ENTER** button.



7. The system update gets started.

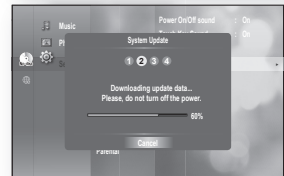

8. If you select Cancel during the download process, you are prompted to confirm your selection in a message box. If you want to cancel the download, select **Yes** and press the **ENTER** button.

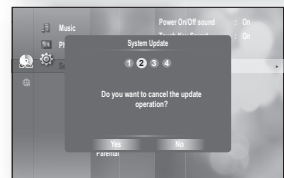

9. Verification will proceed. When download is done, the firmware update process will begin automatically.

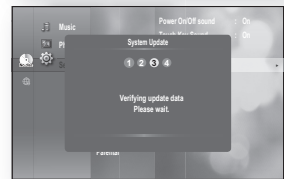

10. When the installation is done, the player will automatically turn off in 5 seconds. All settings will revert to the factory settings the next time you start the system and you will see the menu language selection window.

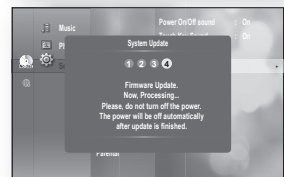

- If you want to cancel the upgrade in the process of downloading the upgrade data, press the **ENTER** button. You will see a confirmation message. Selecting **Yes** will end the upgrade process, and selecting **No** will continue the upgrade process.
- When the system upgrade is done, check the firmware details in the System Upgrade menu.
- Do not turn off the player during the System Upgrade, as it may cause the player to not work properly.



- Do not use USB devices other than USB Flash Drives to do software upgrades using the USB Host jack.
- There should be only one firmware upgrade file in USB flash drive for the player to properly perform an upgrade.
- Oversized USB drives may not be able to be inserted when a LAN or HDMI cable is connected.

## SYSTEM INFORMATION

When the firmware upgrade is done, check the firmware details by following the steps below.

1. With the unit in Stop mode/No Disc mode, press the **MENU** button.
2. Press the **▲▼** buttons to select **Setup**, then press the **ENTER** or **▶** button.
3. Press the **▲▼** buttons to select **System**, then press the **ENTER** or **▶** button.
4. Press the **▲▼** buttons to select **System Information**, then press the **ENTER** or **▶** button.  
You can see detailed information about the current firmware.
5. Press the **ENTER** button to select **OK**.  
System Setup menu will be displayed.

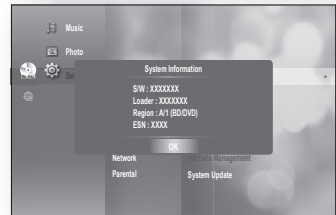
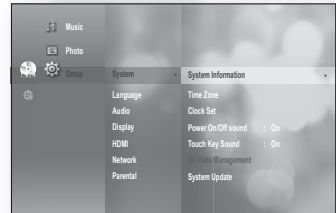
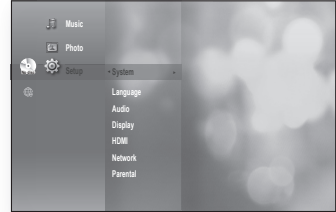

## FIRMWARE UPDATE NOTIFICATION

The popup menu appears when a newer version of the firmware is available from SAMSUNG update server than that of the Blu-ray Disc Player, if the Blu-ray Disc Player is connected to the network and powered on.

- **Yes** : Select this to upgrade now.
- **No** : Select this if you plan to upgrade later.

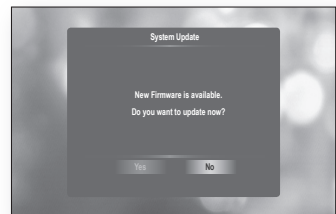

# watching a movie

## USING THE DISPLAY FUNCTION



1. During playback, press the **INFO** button on the remote control.
  - If the Blu-ray Disc has the BONUSVIEW feature, press the **INFO** button in the BONUSVIEW section to display BONUSVIEW-related information.
2. Press the **▲ ▼** buttons to select the desired item.
3. Press the **◀ ▶** buttons to make the desired setup change and then press the **ENTER** button.
  - You may use the number buttons of the remote control to directly access a title, chapter or to start the playback from a desired time.
4. To make the screen disappear, press the **INFO** button again.



<INFO menu for the BONUSVIEW section>

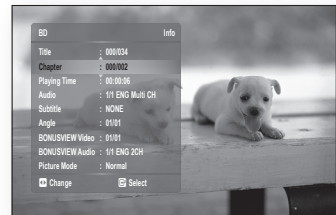

- If you are playing contents from the info menu, some functions may not be enabled depending on the disc.
- Title : To access the desired title when there is more than one in the disc. For example, if there is more than one movie on a Blu-ray Disc/DVD, each movie will be identified as a Title.
- Chapter : Most Blu-ray Disc/DVD discs are recorded in chapters so that you can quickly find a specific chapter.
- Playing Time : Allows playback of the film from a desired time. You must enter the starting time as a reference. The time search function does not operate on some discs.
- Audio : Refers to the film's soundtrack language. A Blu-ray Disc can contain up to 32 audio languages and a DVD up to 8.
- Subtitle : Refers to the subtitle languages available in the disc. You will be able to choose the subtitle languages or, if you prefer, turn them off from the screen. A Blu-ray Disc can contain up to 255 subtitle languages, and a DVD up to 32.
- Angle : When a Blu-ray Disc/DVD contains multiple angles of a particular scene, you can use the ANGLE function.
- BONUSVIEW Video/ BONUSVIEW Audio : You can make BONUSVIEW Video or BONUSVIEW Audio settings if the current title of a Blu-ray Disc appears in the BONUSVIEW section. The BONUSVIEW Video / BONUSVIEW Audio options, however, will be disabled with a Blu-ray Disc that does not support the BONUSVIEW feature.
- Picture Mode : This function enables you to adjust video quality when you are connected to a TV via HDMI.
  - Dynamic : Choose this setting to increase Sharpness.
  - Normal : Choose this setting for most viewing applications.
  - Movie : This is the best setting for watching movies.
  - User : The user can adjust the sharpness and noise reduction function respectively.

# USING THE DISC MENU & POPUP/TITLE MENU

## Using the Disc Menu



1. During playback, press the **DISC MENU** button on the remote control.
2. Press the **▲▼◀▶** buttons to make the desired selection, then press the **▶** or **ENTER** button.
  - The Disc menu setup items may vary from disc to disc.



 ■ Depending on the disc, the Disc Menu may not be available.

## Using the Title Menu



1. During playback, press the **TITLE MENU** button on the remote control.
2. Press the **▲▼◀▶** buttons to make the desired selection, then press the **ENTER** button.
  - The Title menu setup options may vary from disc to disc.

 ■ Depending on the disc, the Title Menu may not be available.  
■ Title Menu will only be displayed if there are at least two titles on the disc.

## Playing the Title List



1. With the unit in Stop mode/Playback mode, press the **DISC MENU** or **TITLE MENU** button.
2. Press the **▲▼** buttons to select an entry you want to play from Title List, then press the **▶** or **ENTER** button. The selected entry (title) will be played back.



### - Go to Playlist -

To go to the Playlist, press the **RED(A)** button.

# watching a movie

## Using the Popup Menu



1. During playback, press the **POPUP MENU** button on the remote control.
2. Press the **▲▼◀▶** buttons or **ENTER** button to select the desired menu.
  - The Popup menu setup options may vary from disc to disc.



-  ■ Depending on the disc, the Popup Menu may not be available.

## REPEAT PLAY

Repeat the current chapter or title.

### Repeat playback



1. During playback, press the **REPEAT** button on the remote control. Repeat screen appears.
2. Press the **▲▼** buttons to select **Chapter** or **Title**.
  - Blu-ray Disc/DVD repeats play by chapter or title.
3. To return to normal play, press the **REPEAT** button again, then press the **▲▼** buttons to select **Off**.





-  ■ Depending on the disc, the Repeat function may not be available.

### Using the A-B Repeat function

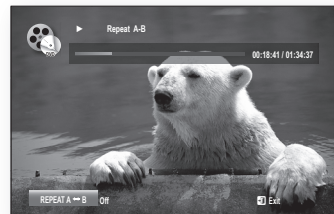

1. Press the **REPEAT A-B** button on the remote control during playback.
2. Press the **REPEAT A-B** button at the point where you want repeat play to start (A).
3. Press the **REPEAT A-B** button at the point where you want repeat play to stop (B).
4. To return to normal play, press the **CANCEL** button.



-  ■ Point B cannot be set until 5 seconds of playback has elapsed from point A.
- Depending on the disc, the REPEAT A-B menu may not be available.

## SELECTING THE AUDIO LANGUAGE



You can select a desired audio language quickly and easily with the **AUDIO** button.

### Using the AUDIO button

1. Press the **AUDIO** button during playback. The Audio changes when the button is pressed repeatedly.
  - The audio languages are represented by abbreviations.
2. To remove the **Audio** bar, press the **CANCEL** or **RETURN** button.

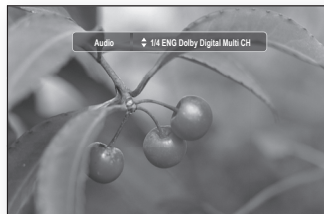

### Using the INFO button

1. During playback, press the **INFO** button on the remote control.
2. Press the **▲▼** buttons to select **Audio**.
3. Press the **◀▶** buttons on the remote control to select the desired audio language.



- This function depends on what audio languages are encoded on the disc and may not be available.
- A Blu-ray Disc can contain up to 32 audio languages and a DVD up to 8.
- Depending on the disc type, you can use the **AUDIO** button to change the audio soundtrack as well as the audio language.  
Some Blu-ray Discs may allow you to select either the multi-channel LPCM or Dolby digital audio soundtrack in English.
- Information about the primary / secondary mode will be also displayed if the Blu-ray Disc has a **BONUSVIEW** section.  
Use the **◀▶** button to switch between primary and secondary audio modes.
- The **◀▶** indicator will not be displayed on the screen if the **BONUSVIEW** section does not contain any **BONUSVIEW** audio settings.

## SELECTING THE SUBTITLE LANGUAGE

You can select a desired subtitle quickly and easily with the **SUBTITLE** button.

### Using the SUBTITLE button



1. Press the **SUBTITLE** button. The subtitle changes when the button is pressed repeatedly. The subtitle languages are represented by abbreviations.
2. To remove the **Subtitle** bar, press the **CANCEL** or **RETURN** button.

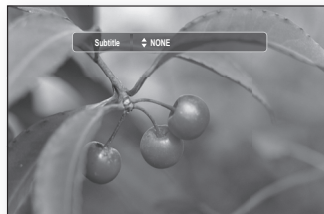

# watching a movie

---

## Using the INFO button

1. During playback, press the **INFO** button on the remote control.
2. Press the **▲▼** buttons to select **Subtitle**.
3. Press the **◀▶** buttons on the remote control to select the desired subtitle language.



- Depending on the Blu-ray Disc / DVD, you may be able to change the desired subtitle in the Disc Menu. Press the **DISC MENU** button.
- This function depends on what subtitles are encoded on the disc and may not be available on all Blu-ray Discs/DVDs.
- A Blu-ray Disc can contain up to 255 subtitle languages and a DVD up to 32.
- Information about the primary / secondary mode will be also displayed if the Blu-ray Disc has a BONUSVIEW section.
- This function changes both the primary and secondary subtitles at the same time.
- The total number of subtitles is the sum of the primary and secondary ones.

## CHANGING THE CAMERA ANGLE

---

When a Blu-ray Disc/DVD contains multiple angles of a particular scene, you can use the ANGLE function.

### Using the ANGLE function



1. During playback, press the **INFO** button on the remote control.
2. Press the **▲▼** buttons to select **Angle**.
3. Press the **◀▶** buttons or you can use the number buttons on the remote control to select the desired angle.



- If the disc has only one angle, this feature won't work. Currently, very few discs have this feature.
- Depending on the disc, these functions may not work.

## BONUSVIEW SETTINGS

The BONUSVIEW feature allows you to view additional content (such as commentaries) in a small screen window while the movie is playing.

### Using the BONUSVIEW button



1. If the current Blu-ray Disc features the BONUSVIEW function, you can use the **BONUSVIEW** button to turn BONUSVIEW On or Off.



2. Each time you press the **BONUSVIEW** button, you can toggle between BONUSVIEW On and BONUSVIEW Off.



- You can change detailed settings of the BONUSVIEW feature in the INFO menu (see page 58: selection of secondary audio, video stream and subtitle etc.).
- If you switch from BONUSVIEW Video, BONUSVIEW Audio will change automatically in accordance with BONUSVIEW Video.
- If the Blu-ray Disc supports only BONUSVIEW Audio, you can just press the **BONUSVIEW** button to turn the secondary audio on or off.

## BD-LIVE™

The Blu-ray Disc player supports BD-LIVE which enables you to enjoy a variety of interactive service contents provided by the disc manufacturer through network connection.

### Using the BD-LIVE Disc

1. Connect the network (see pages 29–30) and check the network setup (see pages 49–53).
2. Insert a Blu-ray disc that supports BD-LIVE.
3. Select the contents provided by the disc manufacturer to enjoy the BD-LIVE.





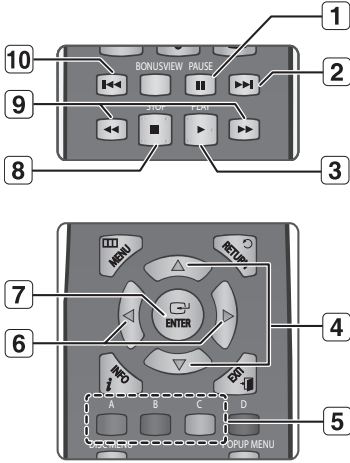

- The way you use BD-LIVE and the features may differ, depending on the disc.
- To use BD-LIVE, you must insert a minimum 1GB USB memory device into one of the USB slots.

# listening to music

## BUTTONS ON THE REMOTE CONTROL USED FOR AUDIO CD (CD-DA)/MP3 PLAYBACK





1. **PAUSE** button : Pauses playback.
2. **SKIP** (  ) button : During playback, moves to the next page in the Music List or moves to the next track in the Playlist.
3. **PLAY** button : Plays the currently selected track.
4. **▲▼** buttons : Selects a track(song) in the Music List or Playlist.
5. **COLOR** buttons
  - **RED(A)** button : Selects the Play Mode(Repeat) during playback.
  - **GREEN(B)** button : Go to Playlist from Music List.
  - **YELLOW(C)** button : Playlist play.
6. **◀▶** buttons : During the playback, these buttons are not available.
  - ◀ : Returns to the Main menu (or high-order)
  - ▶ : Moves to the track (song) menu.
7. **ENTER** button : Plays the selected track (song).
8. **STOP** button : Stops a track(song).
9. Press the **SEARCH** (   ) buttons : Fast Play.
10. **SKIP** (  ) button : If you press this button after three seconds of playback, the current track will be replayed from the beginning. But, if you press this button within three seconds after playback starts, the previous track will be played. Also used to move to the previous page in the Music List or Playlist.

## REPEAT AUDIO CD(CD-DA)/MP3





During playback, press the **REPEAT** or **RED(A)** button repeatedly to select the repeat mode you want.

### ❖ Audio CD (CD-DA)

⇒ →  →  →  → 

### ❖ MP3

⇒ →  →  →  → 

-  **Normal (Audio CD (CD-DA)/MP3)** : Tracks on a disc are played in the order in which they were recorded on the disc.
-  **Repeat Track (Audio CD (CD-DA)/MP3)**
-  **Repeat Folder (MP3)**
-  **Random (Audio CD (CD-DA)/MP3)** : The random option plays a disc's track in random order.
-  **Repeat All (Audio CD (CD-DA))** : All tracks are repeated.

- To return to normal playback -

Press the **REPEAT** or **RED(A)** button repeatedly to return to normal playback.



You can select the data source by pressing the ▲▼ button in the menu screen.  
(CD/DVD/USB memory flash stick)



## PLAYING AN AUDIO CD(CD-DA)/MP3

1. Insert an Audio CD(CD-DA) or an MP3 Disc into the disc tray.
  - For an Audio CD, the first track will be played automatically.
  - For an MP3 disc, press the ▲▼ buttons to select **Music**, then press the **ENTER** button.  
(You can listen to mp3 files using a USB memory flash stick)
2. To move to the Music List, press the **STOP** or **RETURN** button.  
The Music List screen is displayed on your TV.
3. Press the ▲▼ buttons to select the track you want to play, and then press the **ENTER** button.

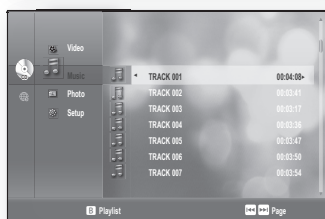
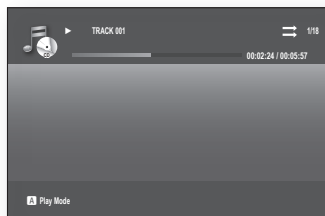

### ❖ Audio CD(CD-DA)/MP3 Screen Elements

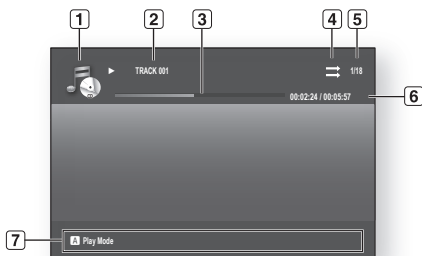

1	Displays the media type.
2	Current track (song) Displays the number or title track currently being played.
3	Play Status Bar.
4	Displays the repeat status.
5	Displays the current play index, total track number.
6	Current /Total Play Time.
7	Displays available <b>COLOR</b> buttons.

# listening to music

## Playlist



You can create a playlist with up to 99 tracks.

1. Insert an Audio CD(CD-DA) or an MP3 Disc into the disc tray.

- For an Audio CD, the first track will be played automatically.
- For an MP3 disc, press the ▲▼ buttons to select **Music**, then press the **ENTER** button.  
(You can listen to mp3 files using a USB memory flash stick)

2. To move to the Music List, press the **GREEN(B)** or **RETURN** button.

The Music List screen is displayed.

3. Press the **GREEN(B)** button to go to the Playlist.

4. Press the ▲▼ buttons to select a track, then press the **ENTER** button to add it to the Playlist. Repeat this procedure to add additional tracks.

5. If there is an undesired track in the playlist, press the ►▲▼ button to select that track, and then press the **ENTER** button.

- The selected track will be deleted.

6. Press the **YELLOW(C)** button to play the selected tracks.

When the track is finished, the next track will automatically play.

7. To edit the Playlist, press the **STOP** or **RETURN** button.

8. To go to the Music List, press the **RETURN** button.

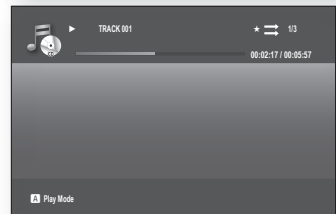
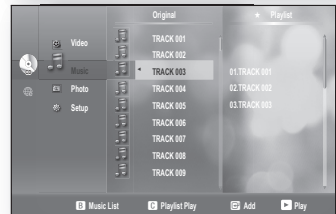
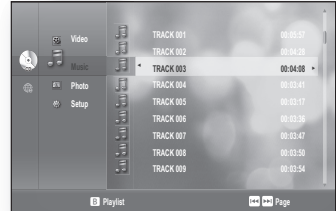



## MP3 & JPEG Simultaneous playback

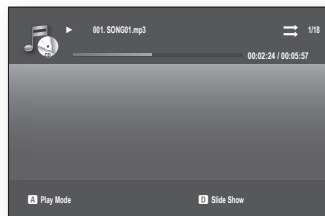

You can enjoy listening to MP3 files while you simultaneously view JPEG files.

1. When you play MP3 file, press the **BLUE(D)** button.  
The slide show speed screen will be displayed.
2. Select the desired slide show speed.



-  To operate this function, you have to select the folder containing both music and photo files.
- When you play MP3 and JPEG files simultaneously, audio drop may occur according to bitrate of MP3, size of JPEG image and method of encoding.

# playing back a picture

## PLAYING A JPEG DISC



1. Insert a JPEG disc into the disc tray.  
(You can watch the jpeg files using a USB memory flash stick)

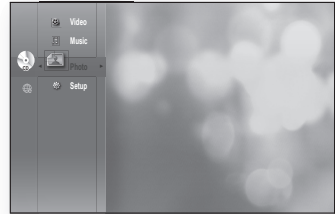

2. Press the ▲▼ buttons to select the **Photo**, and then press the **ENTER** or ► button.



3. Press the ▲▼ buttons to select the folder you want to play, and then press the **ENTER** button.



- 4-1. Press the **BLUE(D)** button to start slide show.

- 4-2. Press the ▲▼ buttons to select the picture you want to play, and then press the **ENTER** button.  
You can operate rotation, zoom and slide show function.

- **RED(A)** button : Each time this button is pressed, the picture rotates 90 degrees counterclockwise.
- **GREEN(B)** button : Each time this button is pressed, the picture rotates 90 degrees clockwise.
- **YELLOW(C)** button : Each time this button is pressed, the picture is enlarged up to 4X (Four times the normal size).
- **BLUE(D)** button : Selects slide show speed.
- **PLAY** button : The picture enters slide show mode.

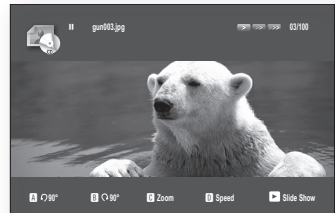

# using the e-contents

With this Blu-ray Disc Player, you can use the e-Contents service (YouTube, for example) via the network.

After performing the network connection (see pages 29~30), check the network setup (see pages 49~53).



- According to company policy, the specifications are subject to change.
- e-Content video playback may pause, stop or buffer, depending on your broadband speed.

## USING BLOCKBUSTER

This Blu-ray Disc Player enables you to use the following services provided by Blockbuster.

1. With the unit in Stop mode/No Disc mode, press the **RED(A)** button on the menu screen.
  - **Movies** : Display movies.
  - **TV Shows** : Display TV Shows.
  - **Find** : Search for a desired movie or TV show by entering it manually.
  - **My Library** : Display a title that you bought or rented.
  - **My Favorites** : Displays a title that has been added to My Favorites.
  - **Configure** : Activate or deactivate the Blu-ray Disc Player.
  - **Help** : Get customer service contact information and check the current software version.
2. If you don't have a Blockbuster account yet, visit [www.blockbuster.com](http://www.blockbuster.com) to create your account.
3. Press the **▲▼◀▶** button to select the **Configure**, then press the **ENTER** button.

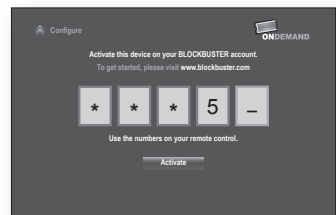

4. Enter the activation code that is created by the web site, then press the **ENTER** button to select **Activate**.  
When the Blu-ray Disc Player is activated, you will move to the Home page.
5. Press the **▶◀** button to select the **Movies** or **TV shows**, then press the **ENTER** button.

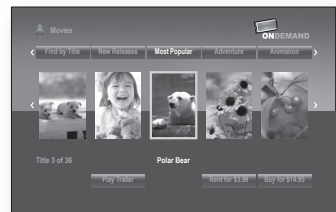

# using the e-contents

6. Press the **▲▼▶▶** button to select the desired title, then press the **ENTER** button.

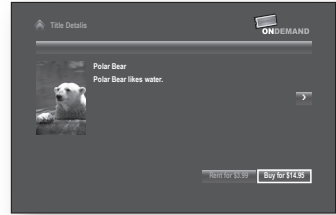

7. Press the **◀▶** button to select the **Rent** or **Buy**, then press the **ENTER** button.

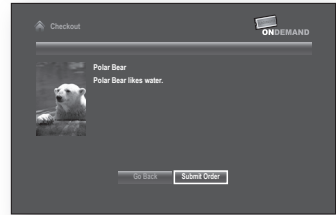

8. Press the **◀▶** button to select the **Submit Order**, then press the **ENTER** button. If you want to play any of the titles that you bought, simply click **Play Now**.

- Depending on the title, some buttons (rent or buy, etc.) may become inactive. For more detailed information, visit [www.blockbuster.com](http://www.blockbuster.com).
- Press the **EXIT** button to exit the Blockbuster. During playback, **EXIT** button is not available.

## USING NETFLIX

This Blu-ray Disc Player enables you to use the following services provided by Netflix.

1. With the unit in Stop mode/No Disc mode, press the **GREEN(B)** button.

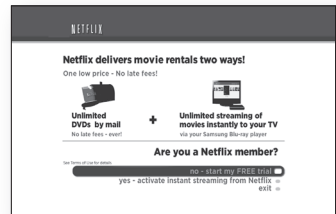

2. If you don't have an account, select "no-start my FREE trial" and subscribe to <http://netflix.com/samsung> from your computer. A user with an existing account can select the "yes-activate instant streaming from Netflix".



- If you have an existing account, you will see the next window if **Yes** was selected. Select "I'm now a member".

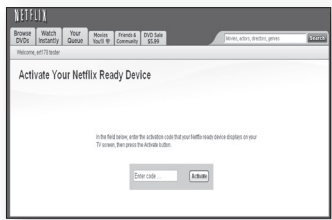

- Video quality of the Netflix contents (SD or HD) depends on the network speed and the original bit rate.
- In order to activate your Blu-ray Disc Player with Netflix, visit the [www.netflix.com/samsung](http://www.netflix.com/samsung) and then enter the activation code.

- To add a movie to the Instant Queue list of this Blu-ray Disc Player, select the "Add to Instant" button on the Netflix "Watch Instantly" web page using your PC.



- Movies you added to the Instant Queue from the web are listed. Press the **ENTER** button of the remote control and select a movie to display the next screen.
  - To add a movie in the Instant Queue list of this Blu-ray Disc Player, select "Add to Instant" button on "Watch Instantly" page of Netflix web site using your PC.



- Press the **PLAY** button to start playback, and the initial buffering of the streamed data is shown.

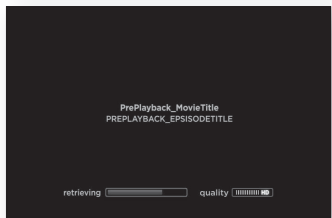

# using the e-contents

7. Press the search button (◀/▶) to select a scene of your choice.
  - To stop the movie or go to the instant movie list, press the upper arrow key or press Stop.

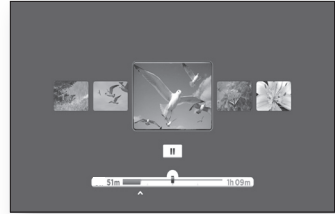

- ▣ For more information on the Netflix Instant Streaming feature visit <http://www.netflix.com/help/tv> or login to your Netflix account and click "Help" at the top of the page.

## USING PANDORA

Pandora provides music personalized to your taste.

1. With the unit in Stop mode/No Disc mode, press the **YELLOW(C)** button.

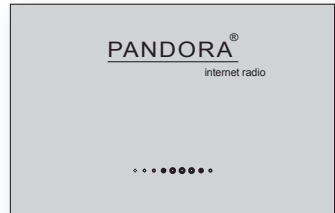

2. To run Pandora, you need to input the activation code at <<http://www.pandora.com/samsung>> page with your PC. After inputting the activation code, you may have to create a new account if you don't have one yet. If you already have an account, you can use the existing account.

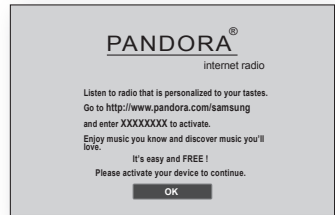

3. It automatically shows the list of stations created from the web or player, and plays music.



4. Press the **RED(A)** button while the highlight is on the station list to display the create station window.



- Enter the keyword and press the **BLUE(D)** button to display the search result.  
(The station keyword should be enter music genre, artist, music title, etc.)

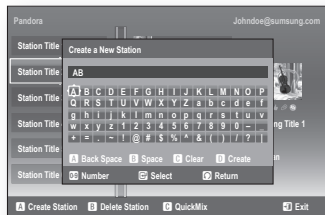

- Press the **GREEN(B)** button while the highlight is on the station list to delete the selected station.

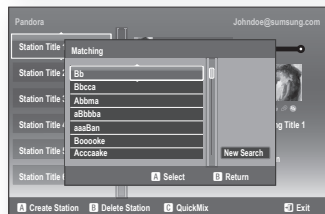

- You can edit your song list by using the color buttons on the remote control while the highlight is on the song list.

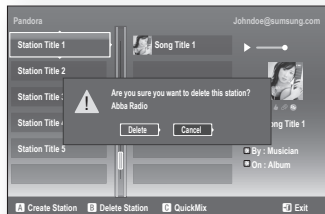

- RED(A)** : Thumbs Up. By indicating your preference to the server, it plays more songs you love.
- GREEN(B)** : Thumbs Down. By indicating your dislike to the server, it plays fewer songs you don't like.
- YELLOW(C)** : Bookmark. It bookmarks the selected song.



- Once bookmarked with this Blu-ray Disc Player, you can find those songs from [www.pandora.com](http://www.pandora.com) using your account and various additional services provided by Pandora web service using your PC.
- BLUE(D)** : Sleep Song. It excludes the selected song from the station for a month.



- The [www.pandora.com](http://www.pandora.com) server reflects the changes made on your player.
- In order to activate your Blu-ray Disc Player with Pandora, visit the [www.pandora.com/samsung](http://www.pandora.com/samsung) and then enter the activation code.
- For further information on Pandora service or to unsubscribe the Pandora service, email "[samsung-support@pandora.com](mailto:samsung-support@pandora.com)".

# using the e-contents

## USING YOUTUBE

This Blu-ray Disc Player enables you to use the following services provided by YouTube.

1. With the unit in Stop mode/No Disc mode, press the **BLUE(D)** button on the menu screen.

### ❖ YouTube screen elements

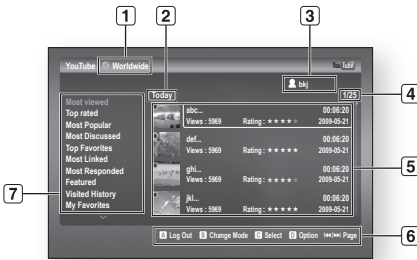

1	Country Selection Information: Shows a country that you selected.
2	Current sorting time: Shows a title list sorted by Time. (Today, Weekly, Monthly, All)
3	User Information: Only shown when logging in.
4	Number of page: The page number of selected title / Total pages in current list.
5	Contents List: Shows a Title, Number of views, Ratings, Runtime and Date.
6	Navigation Help: Shows available buttons.
7	Category List: For more detailed information, please refer to below.

### Category List

Most Viewed	Shows the most viewed videos.
Top Rated	Shows the highest rated videos.
Most Popular	Shows a list of popular videos.
Most Discussed	Shows the most discussed videos.
Top Favorites	Shows the videos that are most added to user's Favorites.
Most Linked	Shows the videos that are most linked to other web sites.
Most Responded	Shows the videos that are most responded by web users.
Featured	Shows a list of featured videos.
Visited History	Shows a history of visited videos.

My Favorites	If you have logged into your YouTube account with the Blu-ray Disc Player and added a video to My Favorites, you can play the video on the Blu-ray Disc Player or a PC that is synchronized with the YouTube site.
Player Library	You can add videos to the Player Library without logging into your YouTube account.
Search	Select search criteria, and enter a keyword for the video you want to play.
Country Setup	Shows a list of videos for a desired country.
Account Management	Enables you to manage YouTube user names and passwords.

## Country Setup

If you select a country in Country Setup, you can view videos from the YouTube site of that country.

1. Press the **▲▼** button to select the **Country Setup**, then press the **ENTER** button.
2. Press the **▲▼◀▶** button to select the desired country, then press the **ENTER** button.



## Log in

If you have logged into your YouTube account with the Blu-ray Disc Player, you can play videos added to My Favorites.

1. Press the **RED(A)** button on the YouTube screen.
2. Press the **▲▼◀▶** button to enter the user name, then press the **YELLOW(C)** button.
3. Press the **▲▼◀▶** button to enter the password, then press the **YELLOW(C)** button.

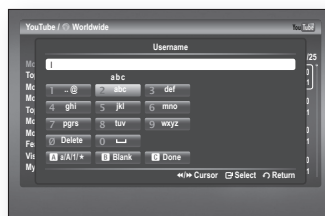

4. Press the **◀▶** button to select **OK**, then press the **ENTER** button.

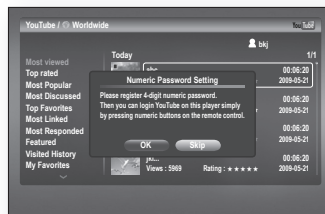

- Press the **RED(A)** button to log out of your YouTube account.

# using the e-contents

5. Enter the 4-digit numeric password.  
You can login YouTube on this Blu-ray Disc Player simply by pressing numeric buttons.



## Playing a video

1. Press the ▲▼ button to select the desired category.

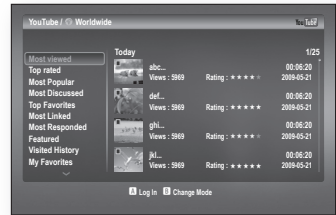

2. Select the current sorting time period (Today, Weekly, Monthly, All) by pressing the **GREEN(B)** button.

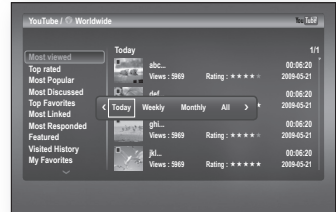

3. Press the ► button to move to the contents list, then press the ▲▼ button to select the desired title.
4. Press the **ENTER** button.

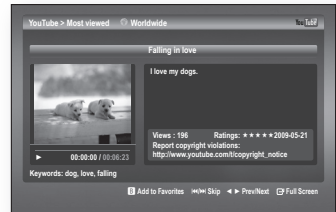

- Press the **ENTER** button to display the video in full screen during playback, and to provide related videos when it ends.
- Depending on Youtube's specifications, HD contents may not play clearly.
- Press the **EXIT** button to exit YouTube.  
During playback, **EXIT** button is not available.

## Searching a video

1. Press the **▲▼** button to select **Search**, then press the **ENTER** button.
2. Press the **◀▶** buttons to select the search criteria, then press the **ENTER** button.
  - **Relevance:** Select this if you want to search for similar videos.
  - **Published:** Select this if you want to sort videos by the created date.
  - **View count:** Select this if you want to sort videos by the view count.
  - **Rating:** Select this if you want to sort videos by the rating.
3. Press the **◀▶** buttons to select **Keyword**, then press the **ENTER** button.

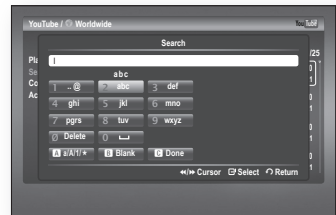
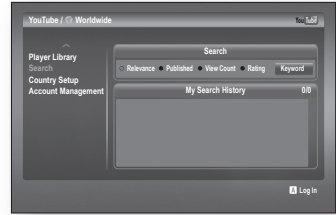

4. Press the **▲▼◀▶** button to select a text field.
5. Press the **ENTER** button in the text field repeatedly to select a desired letter, number or icon.

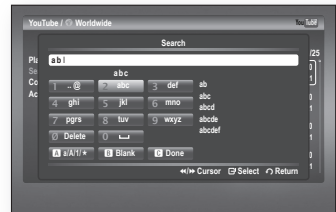

6. After you have entered in the subject you want to search, press the **YELLOW(C)** button on the remote control.

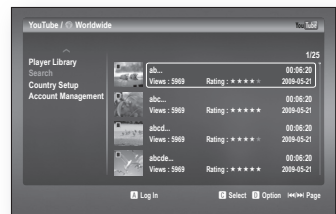

# using the e-contents

7. Press the **▲▼** buttons to select the desired video, then press **ENTER** button to play the video.

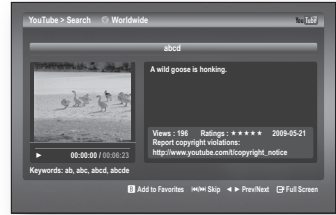

- ☑ Pressing **ENTER** button while you are in the **a/A/1/★** text field enables you to change the text fields to lower case, upper case, numbers and icons.

## My Favorites

If you have logged into your YouTube account with the Blu-ray Disc Player and added a video to My Favorites, you can play the video on the Blu-ray Disc Player or a PC that is synchronized with the YouTube site.

### Saving a video

1. Press the **GREEN(B)** button during playback. The Storage Path popup appears.
2. Press the **▲▼** button to select **My Favorites**, then press the **ENTER** button.
3. Press the **ENTER** button. The desired video will be added to my favorites.

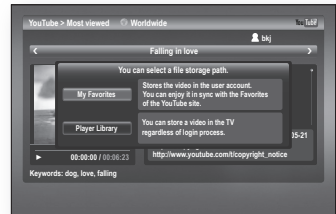

### Playing a video saved in My Favorites

1. Press the **▲▼** button to select the **My Favorites** in the category list.
2. Press the **▶** button to move to the contents list, then press the **▲▼** button to select the desired video.
3. Press the **ENTER** button. The selected video will be played back.

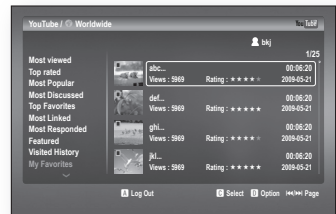

- ☑ If you have logged in your YouTube account, you can also play a video which you added to My Favorites on your PC.

## Player Library

You can add videos to the Player Library without logging into your YouTube account.

### Saving a video

1. Press the **GREEN(B)** button during the playback.
2. Press the **ENTER** button.  
The desired video will be added to player library.

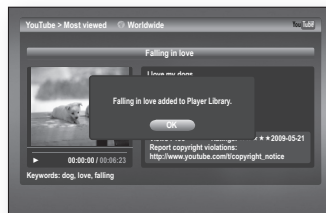

### Playing a video saved in the Player Library

1. Press the **▲▼** button to select the **Player Library** in the category list.
2. Press the **▶** button to move to the contents list, then press the **▲▼** button to select the desired video.
3. Press the **ENTER** button.  
The selected video will be played back.

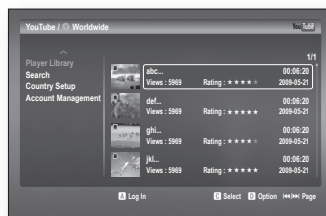

# appendix

## TROUBLESHOOTING

Before requesting service, please check the following.

PROBLEM	SOLUTION
No operation can be performed with the remote control.	<ul style="list-style-type: none"><li>• Check the batteries in the remote control. They may need replacing.</li><li>• Operate the remote control at a distance of no more than 20 feet.</li><li>• Remove batteries and hold down one or more buttons for several minutes to drain the microprocessor inside the remote control to reset it. Reinstall batteries and try to operate the remote control again.</li></ul>
Disc does not play.	<ul style="list-style-type: none"><li>• Ensure that the disc is installed with the label side facing up.</li><li>• Check the region number of the Blu-ray Disc/ DVD.</li></ul>
Disc Menu does not appear.	<ul style="list-style-type: none"><li>• Check if the disc has a Menu.</li></ul>
The  icon appears on the screen.	<ul style="list-style-type: none"><li>• This icon appears when an invalid button is pressed.</li><li>• The features or action cannot be completed at this time because :<ol style="list-style-type: none"><li>1. The Blu-ray Disc/ DVD's software restricts it.</li><li>2. The Blu-ray Disc/ DVD's software doesn't support the feature (e.g., angles)</li><li>3. The feature is not available at the moment.</li><li>4. You've requested a title or chapter number or search time that is out of range.</li></ol></li></ul>
Play mode differs from the Setup Menu selection.	<ul style="list-style-type: none"><li>• Some of the functions selected in the Setup Menu may not work properly if the disc is not encoded with the corresponding function.</li></ul>
The screen ratio cannot be changed.	<ul style="list-style-type: none"><li>• The Screen Ratio is fixed on your Blu-ray Disc/ DVDs.</li><li>• This is not a problem with the player.</li></ul>
No audio.	<ul style="list-style-type: none"><li>• Make sure you have selected the correct Digital Output in the Audio Options Menu.</li></ul>
The screen is blocked	<ul style="list-style-type: none"><li>• Press the <b>SKIP (▶▶)</b> button (on front panel) for more than 5 seconds with no disc inside. All settings will revert to the factory settings.</li><li>• When the factory default settings are restored, all the user data stored in the BD data will be deleted.</li></ul>
If the HDMI output is set to a resolution your TV cannot support (for example, 1080p), you may not see a picture on your TV.	<ul style="list-style-type: none"><li>• Press the <b>SKIP (▶▶)</b> button (on front panel) for more than 5 seconds with no disc inside. All settings will revert to the factory settings.</li><li>• When the factory default settings are restored, all the user data stored in the BD data will be deleted.</li></ul>
Forgot password	<ul style="list-style-type: none"><li>• Press the <b>SKIP (▶▶)</b> button (on front panel) for more than 5 seconds with no disc inside. All settings including the password will revert to the factory settings. Don't use this unless absolutely necessary.</li><li>• When the factory default settings are restored, all the user data stored in the BD data will be deleted.</li></ul>



PROBLEM	SOLUTION
If you experience other problems.	<ul style="list-style-type: none"> <li>• Go to the contents and find the section of the instruction manual that contains the explanations regarding the current problem, and follow the procedure once again.</li> <li>• If the problem still cannot be solved, please contact your nearest Samsung authorized service center or call 1-800-SAMSUNG.</li> </ul>
The picture is noisy or distorted	<ul style="list-style-type: none"> <li>• Make sure that the disc is not dirty or scratched.</li> <li>• Clean the disc.</li> </ul>
No HDMI output.	<ul style="list-style-type: none"> <li>• Check the connection between the TV and the HDMI jack of the Blu-ray Disc Player.</li> <li>• Check if your TV supports 480p/720p/1080i/1080p HDMI input resolution.</li> </ul>
Abnormal HDMI output screen.	<ul style="list-style-type: none"> <li>• If random noise appears on the screen, it means that TV does not support HDCP (High-bandwidth Digital Content Protection).</li> </ul>



▪ When the factory default settings are restored, all the user data stored in the BD data will be deleted.

# appendix

## SPECIFICATIONS

General	Power Requirements	AC 120V, 60Hz
	Power Consumption	30 W
	Weight	4.8 lbs
	Dimensions	BD-P1600 : 16.9(W) × 8.2(D) × 2.1(H) inches BD-P1590(C) : 16.9(W) × 7.8(D) × 2.1(H) inches
	Operating Temperature Range	+41 °F to +95 °F
	Operating Humidity Range	10 % to 75 %
Disc	BD (Blu-ray Disc)	Reading Speed : 4.917m/sec
	DVD (Digital Versatile Disc)	Reading Speed : 3.49 ~ 4.06 m/sec. Approx. Play Time (Single Sided, Single Layer Disc) : 135 min.
	CD : 5 inches (COMPACT DISC)	Reading Speed : 4.8 ~ 5.6 m/sec. Maximum Play Time : 74 min.
	CD : 3 1/2 inches (COMPACT DISC)	Reading Speed : 4.8 ~ 5.6 m/sec. Maximum Play Time : 20 min.
Video Output	Composite Video	1 Channel : 1.0 Vp-p (75 Ω load) Blu-ray/DVD Disc : 480i
	Component Video	Y : 1.0 Vp-p (75 Ω load) Pr : 0.70 Vp-p (75 Ω load) Pb : 0.70 Vp-p (75 Ω load) Blu-ray Disc : 1080i, 720p, 480p, 480i    DVD : 480p, 480i
Video/Audio	HDMI	1080p, 1080i, 720p, 480p PCM multichannel audio, Bitstream audio
Audio Output	2 Channel	L(1/L), R(2/R)
	Digital Audio Output	Optical
	*Frequency Response	48 kHz Sampling : 4 Hz to 22 kHz 96 kHz Sampling : 4 Hz to 44 kHz
	*S/N Ratio	110 dB
	*Dynamic Range	100 dB
	*Total Harmonic Distortion	0.003%

\*: Nominal specification

- Samsung Electronics Co., Ltd reserves the right to change the specifications without notice.
- Weight and dimensions are approximate.

# NOTICE & DISCLAIMER

## Copy Protection

- Because AACS (Advanced Access Content System) is approved as content protection system for Blu-ray Disc format, similar to use of CSS (Content Scramble System) for DVD format, certain restrictions are imposed on playback, analog signal output, etc., of AACS protected contents. The operation of this product and restrictions on this product may vary depending on your time of purchase as those restrictions may be adopted and/or changed by AACS after the production of this product. Furthermore, BD-ROM Mark and BD+ are additionally used as content protection system for Blu-ray Disc format, which imposes certain restrictions including playback restrictions for BD-ROM Mark and/or BD+ protected contents. To obtain additional information on AACS, BD-ROM Mark, BD+, or this product, please contact SAMSUNG customer care center.
- Many Blu-ray Disc/DVD discs are encoded with copy protection. Because of this, you should only connect your Blu-ray Disc Player directly to your TV, not to a VCR. Connecting to a VCR results in a distorted picture from copy-protected Blu-ray Disc/DVD discs.
- This product incorporates copyright protection technology that is protected by methods claims of certain U.S. patents and other intellectual property rights owned by Macrovision Corporation and other rights owners. Use of this copyright protection technology must be authorized by Macrovision Corporation and is intended for home and other limited viewing uses only, unless otherwise authorized by Macrovision Corporation. Reverse engineering or disassembly is prohibited.
- This device is protected by U.S. Patent Nos. 5,315,448; 5,583,936; 6,501,842; 6,381,747; 6,516,132; 6,836,549; and 7,050,698.
- Under the U.S. Copyright laws and Copyright laws of other countries, unauthorized recording, use, display, distribution, or revision of television programs, videotapes, Blu-ray Discs, DVDs, and other materials may subject you to civil and/or criminal liability.
- **For Blu-ray Disc Players progressive scan output :** CONSUMERS SHOULD NOTE THAT NOT ALL HIGH DEFINITION TELEVISION SETS ARE FULLY COMPATIBLE WITH THIS PRODUCT AND MAY CAUSE ARTIFACTS TO BE DISPLAYED IN THE PICTURE. IN CASE OF PROGRESSIVE SCAN PICTURE PROBLEMS, IT IS RECOMMENDED THAT THE USER SWITCH THE CONNECTION TO THE 'STANDARD DEFINITION' OUTPUT. IF THERE ARE QUESTIONS REGARDING OUR TV SET COMPATIBILITY WITH THIS PRODUCT, PLEASE CONTACT OUR CUSTOMER SERVICE CENTER.

## Compliance and Compatibility Notice

NOT ALL discs are compatible

- Subject to the restrictions described below and those noted throughout this Manual, including the Disc Type and Characteristics section of this Manual, disc types that can be played are: pre-recorded commercial BD-ROM, DVD-Video, and Audio CD discs; BD-RE, BD-R, DVD-RW / DVD-R discs; and CD-RW/CD-R discs.
- Discs other than the above cannot and/or is not intended to be played by this player. And some of the above discs may not play due to one or more reasons provided below.
- Samsung cannot assure that this player will play every disc bearing the BD-ROM, BD-RE, BD-R, DVD-Video, DVD-RW/DVD-R and CD-RW/CD-R logos, and this player may not respond to all operating commands or operate all features of every disc. These and other disc compatibility and player operation issues with new and existing format discs are possible because:
  - Blu-ray is a new and evolving format and this player may not operate all features of Blu-ray Discs because some features may be optional, additional features may have been added to the Blu-ray Disc format after the production of this player, and certain available features may be subject to delayed availability;
  - not all new and existing disc format versions are supported by this player;
  - new and existing disc formats may be revised, changed, updated, improved and/or supplemented;
  - some discs are produced in a manner that allows specific or limited operation and feature during playback;
  - some features may be optional, additional features may have been added after the production of this player or certain available features may be subject to delayed availability;
  - some discs bearing the BD-ROM, BD-RE, BD-R, DVD-Video, DVD-RW/ DVD-R and CD-RW/CD-R logos may still be non-standardized discs;
  - some discs may not be played depending on their physical state or recording conditions;
  - problems and errors can occur during the creation of Blu-ray Disc, DVD software and/or the manufacture of discs;
  - this player operates differently than a standard DVD player or other AV equipment; and/or
  - for reasons noted throughout this Manual and for other reason(s) discovered and posted by SAMSUNG customer care center.
- If you encounter disc compatibility or player operation problems, please contact SAMSUNG customer care center. You may also contact SAMSUNG customer care center for possible updates on this player.
- For additional information on playback restrictions and disc compatibility, refer to the Precautions, Before Reading the User's Manual, Disc Types and Characteristics, and Before Playing sections of this Manual.

## Network Service Disclaimer

All content and services accessible through this device belong to third parties and are protected by copyright, patent, trademark and/or other intellectual property laws. Such content and services are provided solely for your personal noncommercial use. You may not use any content or services in a manner that has not been authorized by the content owner or service provider. Without limiting the foregoing, unless expressly authorized by the applicable content owner or service provider, you may not modify, copy, republish, upload, post, transmit, translate, sell, create derivative works, exploit, or distribute in any manner or medium any content or services displayed through this device.

THIRD PARTY CONTENT AND SERVICES ARE PROVIDED "AS IS." SAMSUNG DOES NOT WARRANT CONTENT OR SERVICES SO PROVIDED, EITHER EXPRESSLY OR IMPLIEDLY, FOR ANY PURPOSE. SAMSUNG EXPRESSLY DISCLAIMS ANY IMPLIED WARRANTIES, INCLUDING BUT NOT LIMITED TO, WARRANTIES OF MERCHANTABILITY OR FITNESS FOR A PARTICULAR PURPOSE. SAMSUNG DOES NOT GUARANTEE THE ACCURACY, VALIDITY, TIMELINESS, LEGALITY, OR COMPLETENESS OF ANY CONTENT OR SERVICE MADE AVAILABLE THROUGH THIS DEVICE AND UNDER NO CIRCUMSTANCES, INCLUDING NEGLIGENCE, SHALL SAMSUNG BE LIABLE, WHETHER IN CONTRACT OR TORT, FOR ANY DIRECT, INDIRECT, INCIDENTAL, SPECIAL OR CONSEQUENTIAL DAMAGES, ATTORNEY FEES, EXPENSES, OR ANY OTHER DAMAGES ARISING OUT OF, OR IN CONNECTION WITH, ANY INFORMATION CONTAINED IN, OR AS A RESULT OF THE USE OF ANY CONTENT OR SERVICE BY YOU OR ANY THIRD PARTY, EVEN IF ADVISED OF THE POSSIBILITY OF SUCH DAMAGES.

Third party services may be terminated or interrupted at any time, and Samsung makes no representation or warranty that any content or service will remain available for any period of time. Content and services are transmitted by third parties by means of networks and transmission facilities over which Samsung has no control. Without limiting the generality of this disclaimer, Samsung expressly disclaims any responsibility or liability for any interruption or suspension of any content or service made available through this device.

Samsung is neither responsible nor liable for customer service related to the content and services. Any question or request for service relating to the content or services should be made directly to the respective content and service providers.

- ❖ This product uses parts of the software from the Independent JPEG Group.
  - ❖ This product uses parts of the software owned by the Freetype Project ([www.freetype.org](http://www.freetype.org)).
  - ❖ This product uses some software programs which are distributed under the GPL/LGPL license.
  - ❖ This Product uses some software programs which are distributed under the OpenSSL license.
- Accordingly, the following GPL and LGPL software source codes that have been used in this product can be provided after asking to [vdswmanager@samsung.com](mailto:vdswmanager@samsung.com).
- GPL software: Linux Kernel, Busybox, Binutils
- LGPL software: UClibc, directfb

## The GNU General Public License (GPL)

### Version 2, June 1991

Copyright (C) 1989, 1991 Free Software Foundation, Inc.  
59 Temple Place, Suite 330, Boston, MA 02111-1307 USA

Everyone is permitted to copy and distribute verbatim copies of this license document, but changing it is not allowed.

#### Preamble

The licenses for most software are designed to take away your freedom to share and change it. By contrast, the GNU General Public License is intended to guarantee your freedom to share and change free software--to make sure the software is free for all its users. This General Public License applies to most of the Free Software Foundation's software and to any other program whose authors commit to using it. (Some other Free Software Foundation software is covered by the GNU Library General Public License instead.) You can apply it to your programs, too.

When we speak of free software, we are referring to freedom, not price. Our General Public Licenses are designed to make sure that you have the freedom to distribute copies of free software (and charge for this service if you wish), that you receive source code or can get it if you want it, that you can change the software or use pieces of it in new free programs; and that you know you can do these things.

To protect your rights, we need to make restrictions that forbid anyone to deny you these rights or to ask you to surrender the rights. These restrictions translate to certain responsibilities for you if you distribute copies of the software, or if you modify it.

For example, if you distribute copies of such a program, whether gratis or for a fee, you must give the recipients all the rights that you have. You must make sure that they, too, receive or can get the source code. And you must show them these terms so they know their rights.

We protect your rights with two steps: (1) copyright the software, and (2) offer you this license which gives you legal permission to copy, distribute and/or modify the software.

Also, for each author's protection and ours, we want to make certain that everyone understands that there is no warranty for this free software. If the software is modified by someone else and passed on, we want its recipients to know that what they have is not the original, so that any problems introduced by others will not reflect on the original authors' reputations.

Finally, any free program is threatened constantly by software patents. We wish to avoid the danger that redistributors of a free program will individually obtain patent licenses, in effect making the program proprietary. To prevent this, we have made it clear that any patent must be licensed for everyone's free use or not licensed at all.

The precise terms and conditions for copying, distribution and modification follow.

#### TERMS AND CONDITIONS FOR COPYING, DISTRIBUTION AND MODIFICATION

0. This License applies to any program or other work which contains a notice placed by the copyright holder saying it may be distributed under the terms of this General Public License. The "Program", below, refers to any such program or work, and a "work based on the Program" means either the Program or any derivative work under copyright law: that is to say, a work containing the Program or a portion of it, either verbatim or with modifications and/or translated into another language. (Hereinafter, translation is included without limitation in the term "modification".) Each licensee is addressed as "you".

Activities other than copying, distribution and modification are not covered by this License; they are outside its scope. The act of running the Program is not restricted, and the output from the Program is covered only if its contents constitute a work based on the Program (independent of having been made by running the Program). Whether that is true depends on what the Program does.

**1.** You may copy and distribute verbatim copies of the Program's source code as you receive it, in any medium, provided that you conspicuously and appropriately publish on each copy an appropriate copyright notice and disclaimer of warranty; keep intact all the notices that refer to this License and to the absence of any warranty; and give any other recipients of the Program a copy of this License along with the Program.

You may charge a fee for the physical act of transferring a copy, and you may at your option offer warranty protection in exchange for a fee.

**2.** You may modify your copy or copies of the Program or any portion of it, thus forming a work based on the Program, and copy and distribute such modifications or work under the terms of Section 1 above, provided that you also meet all of these conditions:

- a) You must cause the modified files to carry prominent notices stating that you changed the files and the date of any change.
- b) You must cause any work that you distribute or publish, that in whole or in part contains or is derived from the Program or any part thereof, to be licensed as a whole at no charge to all third parties under the terms of this License.
- c) If the modified program normally reads commands interactively when run, you must cause it, when started running for such interactive use in the most ordinary way, to print or display an announcement including an appropriate copyright notice and a notice that there is no warranty (or else, saying that you provide a warranty) and that users may redistribute the program under these conditions, and telling the user how to view a copy of this License. (Exception: if the Program itself is interactive but does not normally print such an announcement, your work based on the Program is not required to print an announcement.)

These requirements apply to the modified work as a whole. If identifiable sections of that work are not derived from the Program, and can be reasonably considered independent and separate works in themselves, then this License, and its terms, do not apply to those sections when you distribute them as separate works. But when you distribute the same sections as part of a whole which is a work based on the Program, the distribution of the whole must be on the terms of this License, whose permissions for other licensees extend to the entire whole, and thus to each and every part regardless of who wrote it.

Thus, it is not the intent of this section to claim rights or contest your rights to work written entirely by you; rather, the intent is to exercise the right to control the distribution of derivative or collective works based on the Program.

In addition, mere aggregation of another work not based on the Program with the Program (or with a work based on the Program) on a volume of a storage or distribution medium does not bring the other work under the scope of this License.

**3.** You may copy and distribute the Program (or a work based on it, under Section 2) in object code or executable form under the terms of Sections 1 and 2 above provided that you also do one of the following:

- a) Accompany it with the complete corresponding machine-readable source code, which must be distributed under the terms of Sections 1 and 2 above on a medium customarily used for software interchange; or,
- b) Accompany it with a written offer, valid for at least three years, to give any third party, for a charge no more than your cost of physically performing source distribution, a complete machine-readable copy of the corresponding source code, to be distributed under the terms of Sections 1 and 2 above on a medium customarily used for software interchange; or,
- c) Accompany it with the information you received as to the offer to distribute corresponding source code. (This alternative is allowed only for noncommercial distribution and only if you received the program in object code or executable form with such an offer, in accord with Subsection b above.)

The source code for a work means the preferred form of the work for making modifications to it. For an executable work, complete source code means all the source code for all modules it contains, plus any associated interface definition files, plus the scripts used to control compilation and installation of the executable. However, as a special exception, the source code distributed need not include anything that is normally distributed (in either source or binary form) with the major components (compiler, kernel, and so on) of the operating system on which the executable runs, unless that component itself accompanies the executable.

If distribution of executable or object code is made by offering access to copy from a designated place, then offering equivalent access to copy the source code from the same place counts as distribution of the source code, even though third parties are not compelled to copy the source along with the object code.

**4.** You may not copy, modify, sublicense, or distribute the Program except as expressly provided under this License. Any attempt otherwise to copy, modify, sublicense or distribute the Program is void, and will automatically terminate your rights under this License. However, parties who have received copies, or rights, from you under this License will not have their licenses terminated so long as such parties remain in full compliance.

**5.** You are not required to accept this License, since you have not signed it. However, nothing else grants you permission to modify or distribute the Program or its derivative works. These actions are prohibited by law if you do not accept this License. Therefore, by modifying or distributing the Program (or any work based on the Program), you indicate your acceptance of this License to do so, and all its terms and conditions for copying, distributing or modifying the Program or works based on it.

**6.** Each time you redistribute the Program (or any work based on the Program), the recipient automatically receives a license from the original licensor to copy, distribute or modify the Program subject to these terms and conditions. You may not impose any further restrictions on the recipients' exercise of the rights granted herein. You are not responsible for enforcing compliance by third parties to this License.

**7.** If, as a consequence of a court judgment or allegation of patent infringement or for any other reason (not limited to patent issues), conditions are imposed on you (whether by court order, agreement or otherwise) that contradict the conditions of this License, they do not excuse you from the conditions of this License. If you cannot distribute so as to satisfy simultaneously your obligations under this License and any other pertinent obligations, then as a consequence you may not distribute the Program at all. For example, if a patent license would not permit royalty-free redistribution of the Program by all those who receive copies directly or indirectly through you, then the only way you could satisfy both it and this License would be to refrain entirely from distribution of the Program.

If any portion of this section is held invalid or unenforceable under any particular circumstance, the balance of the section is intended to apply and the section as a whole is intended to apply in other circumstances.

It is not the purpose of this section to induce you to infringe any patents or other property right claims or to contest validity of any such claims; this section has the sole purpose of protecting the integrity of the free software distribution system, which is implemented by public license practices. Many people have made generous contributions to the wide range of software distributed through that system in reliance on consistent application of that system; it is up to the author/donor to decide if he or she is willing to distribute software through any other system and a licensee cannot impose that choice.

This section is intended to make thoroughly clear what is believed to be a consequence of the rest of this License.

**8.** If the distribution and/or use of the Program is restricted in certain countries either by patents or by copyrighted interfaces, the original copyright holder who places the Program under this License may add an explicit geographical distribution limitation excluding those countries, so that distribution is permitted only in or among countries not thus excluded. In such case, this License incorporates the limitation as if written in the body of this License.

**9.** The Free Software Foundation may publish revised and/or new versions of the General Public License from time to time. Such new versions will be similar in spirit to the present version, but may differ in detail to address new problems or concerns.

Each version is given a distinguishing version number. If the Program specifies a version number of this License which applies to it and "any later version", you have the option of following the terms and conditions either of that version or of any later version published by the Free Software Foundation. If the Program does not specify a version number of this License, you may choose any version ever published by the Free Software Foundation.

**10.** If you wish to incorporate parts of the Program into other free programs whose distribution conditions are different, write to the author to ask for permission. For software which is copyrighted by the Free Software Foundation, write to the Free Software Foundation; we sometimes make exceptions for this. Our decision will be guided by the two goals of preserving the free status of all derivatives of our free software and of promoting the sharing and reuse of software generally.

## NO WARRANTY

**11.** BECAUSE THE PROGRAM IS LICENSED FREE OF CHARGE, THERE IS NO WARRANTY FOR THE PROGRAM, TO THE EXTENT PERMITTED BY APPLICABLE LAW. EXCEPT WHEN OTHERWISE STATED IN WRITING THE COPYRIGHT HOLDERS AND/OR OTHER PARTIES PROVIDE THE PROGRAM "AS IS" WITHOUT WARRANTY OF ANY KIND, EITHER EXPRESSED OR IMPLIED, INCLUDING, BUT NOT LIMITED TO, THE IMPLIED WARRANTIES OF MERCHANTABILITY AND FITNESS FOR A PARTICULAR PURPOSE. THE ENTIRE RISK AS TO THE QUALITY AND PERFORMANCE OF THE PROGRAM IS WITH YOU. SHOULD THE PROGRAM PROVE DEFECTIVE, YOU ASSUME THE COST OF ALL NECESSARY SERVICING, REPAIR OR CORRECTION.

**12.** IN NO EVENT UNLESS REQUIRED BY APPLICABLE LAW OR AGREED TO IN WRITING WILL ANY COPYRIGHT HOLDER, OR ANY OTHER PARTY WHO MAY MODIFY AND/OR REDISTRIBUTE THE PROGRAM AS PERMITTED ABOVE, BE LIABLE TO YOU FOR DAMAGES, INCLUDING ANY GENERAL, SPECIAL, INCIDENTAL OR CONSEQUENTIAL DAMAGES ARISING OUT OF THE USE OR INABILITY TO USE THE PROGRAM (INCLUDING BUT NOT LIMITED TO LOSS OF DATA OR DATA BEING RENDERED INACCURATE OR LOSSES SUSTAINED BY YOU OR THIRD PARTIES OR A FAILURE OF THE PROGRAM TO OPERATE WITH ANY OTHER PROGRAMS), EVEN IF SUCH HOLDER OR OTHER PARTY HAS BEEN ADVISED OF THE POSSIBILITY OF SUCH DAMAGES.

END OF TERMS AND CONDITIONS

### How to Apply These Terms to Your New Programs

If you develop a new program, and you want it to be of the greatest possible use to the public, the best way to achieve this is to make it free software which everyone can redistribute and change under these terms.

To do so, attach the following notices to the program. It is safest to attach them to the start of each source file to most effectively convey the exclusion of warranty; and each file should have at least the "copyright" line and a pointer to where the full notice is found.

One line to give the program's name and a brief idea of what it does.

Copyright (C) <year> <name of author>

This program is free software; you can redistribute it and/or modify it under the terms of the GNU General Public License as published by the Free Software Foundation; either version 2 of the License, or (at your option) any later version.

This program is distributed in the hope that it will be useful, but WITHOUT ANY WARRANTY; without even the implied warranty of MERCHANTABILITY or FITNESS FOR A PARTICULAR PURPOSE. See the GNU General Public License for more details.

You should have received a copy of the GNU General Public License along with this program; if not, write to the Free Software Foundation, Inc., 59

Temple Place, Suite 330, Boston, MA 02111-1307 USA

Also add information on how to contact you by electronic and paper mail.

If the program is interactive, make it output a short notice like this when it starts in an interactive mode:

Gnomovision version 69, Copyright (C) year name of author Gnomovision comes with ABSOLUTELY NO WARRANTY; for details type `show w'. This is free software, and you are welcome to redistribute it under certain conditions; type `show c' for details.

The hypothetical commands `show w' and `show c' should show the appropriate parts of the General Public License. Of course, the commands you use may be called something other than `show w' and `show c'; they could even be mouse-clicks or menu items--whatever suits your program.

You should also get your employer (if you work as a programmer) or your school, if any, to sign a "copyright disclaimer" for the program, if necessary. Here is a sample; alter the names:

Yoyodyne, Inc., hereby disclaims all copyright interest in the program 'Gnomovision' (which makes passes at compilers) written by James Hacker.

signature of Ty Coon, 1 April 1989

Ty Coon, President of Vice

This General Public License does not permit incorporating your program into proprietary programs. If your program is a subroutine library, you may consider it more useful to permit linking proprietary applications with the library. If this is what you want to do, use the GNU Library General Public License instead of this License.



# GNU Lesser General Public License (LGPL)

Version 2.1, February 1999

Copyright (C) 1991, 1999 Free Software Foundation, Inc. 59 Temple Place, Suite 330, Boston, MA 02111-1307 USA Everyone is permitted to copy and distribute verbatim copies of this license document, but changing it is not allowed.

[This is the first released version of the Lesser GPL. It also counts as the successor of the GNU Library Public License, version 2, hence the version number 2.1.]

## Preamble

The licenses for most software are designed to take away your freedom to share and change it. By contrast, the GNU General Public Licenses are intended to guarantee your freedom to share and change free software--to make sure the software is free for all its users.

This license, the Lesser General Public License, applies to some specially designated software packages--typically libraries--of the Free Software Foundation and other authors who decide to use it. You can use it too, but we suggest you first think carefully about whether this license or the ordinary General Public License is the better strategy to use in any particular case, based on the explanations below.

When we speak of free software, we are referring to freedom of use, not price. Our General Public Licenses are designed to make sure that you have the freedom to distribute copies of free software (and charge for this service if you wish); that you receive source code or can get it if you want it; that you can change the software and use pieces of it in new free programs; and that you are informed that you can do these things.

To protect your rights, we need to make restrictions that forbid distributors to deny you these rights or to ask you to surrender these rights. These restrictions translate to certain responsibilities for you if you distribute copies of the library or if you modify it.

For example, if you distribute copies of the library, whether gratis or for a fee, you must give the recipients all the rights that we gave you. You must make sure that they, too, receive or can get the source code. If you link other code with the library, you must provide complete object files to the recipients, so that they can relink them with the library after making changes to the library and recompiling it. And you must show them these terms so they know their rights.

We protect your rights with a two-step method: (1) we copyright the library, and (2) we offer you this license, which gives you legal permission to copy, distribute and/or modify the library.

To protect each distributor, we want to make it very clear that there is no warranty for the free library. Also, if the library is modified by someone else and passed on, the recipients should know that what they have is not the original version, so that the original author's reputation will not be affected by problems that might be introduced by others.

Finally, software patents pose a constant threat to the existence of any free program. We wish to make sure that a company cannot effectively restrict the users of a free program by obtaining a restrictive license from a patent holder. Therefore, we insist that any patent license obtained for a version of the library must be consistent with the full freedom of use specified in this license.

Most GNU software, including some libraries, is covered by the ordinary GNU General Public License. This license, the GNU Lesser General Public License, applies to certain designated libraries, and is quite different from the ordinary General Public License. We use this license for certain libraries in order to permit linking those libraries into non-free programs.

When a program is linked with a library, whether statically or using a shared library, the combination of the two is legally speaking a combined work, a derivative of the original library. The ordinary General Public License therefore permits such linking only if the entire combination fits its criteria of freedom.

The Lesser General Public License permits more lax criteria for linking other code with the library.

We call this license the "Lesser" General Public License because it does Less to protect the user's freedom than the ordinary General Public License. It also provides other free software developers Less of an advantage over competing non-free programs. These disadvantages are the reason we use the ordinary General Public License for many libraries. However, the Lesser license provides advantages in certain special circumstances.

For example, on rare occasions, there may be a special need to encourage the widest possible use of a certain library, so that it becomes a de-facto standard. To achieve this, non-free programs must be allowed to use the library. A more frequent case is that a free library does the same job as widely used non-free libraries. In this case, there is little to gain by limiting the free library to free software only, so we use the Lesser General Public License.

In other cases, permission to use a particular library in non-free programs enables a greater number of people to use a large body of free software. For example, permission to use the GNU C Library in non-free programs enables many more people to use the whole GNU operating system, as well as its variant, the GNU/Linux operating system.

Although the Lesser General Public License is less protective of the users' freedom, it does ensure that the user of a program that is linked with the Library has the freedom and the wherewithal to run that program using a modified version of the Library.

The precise terms and conditions for copying, distribution and modification follow. Pay close attention to the difference between a "work based on the library" and a "work that uses the library". The former contains code derived from the library, whereas the latter must be combined with the library in order to run.

## **TERMS AND CONDITIONS FOR COPYING, DISTRIBUTION AND MODIFICATION**

**0.** This License Agreement applies to any software library or other program which contains a notice placed by the copyright holder or other authorized party saying it may be distributed under the terms of this Lesser General Public License (also called "this License"). Each licensee is addressed as "you".

A "library" means a collection of software functions and/or data prepared so as to be conveniently linked with application programs (which use some of those functions and data) to form executables.

The "Library", below, refers to any such software library or work which has been distributed under these terms. A "work based on the Library" means either the Library or any derivative work under copyright law: that is to say, a work containing the Library or a portion of it, either verbatim or with modifications and/or translated straightforwardly into another language. (Hereinafter, translation is included without limitation in the term "modification".)

"Source code" for a work means the preferred form of the work for making modifications to it. For a library, complete source code means all the source code for all modules it contains, plus any associated interface definition files, plus the scripts used to control compilation and installation of the library.

Activities other than copying, distribution and modification are not covered by this License; they are outside its scope. The act of running a program using the Library is not restricted, and output from such a program is covered only if its contents constitute a work based on the Library (independent of the use of the Library in a tool for writing it). Whether that is true depends on what the Library does and what the program that uses the Library does.

**1.** You may copy and distribute verbatim copies of the Library's complete source code as you receive it, in any medium, provided that you conspicuously and appropriately publish on each copy an appropriate copyright notice and disclaimer of warranty; keep intact all the notices that refer to this License and to the absence of any warranty; and distribute a copy of this License along with the Library.

You may charge a fee for the physical act of transferring a copy, and you may at your option offer warranty protection in exchange for a fee.

**2.** You may modify your copy or copies of the Library or any portion of it, thus forming a work based on the Library, and copy and distribute such modifications or work under the terms of Section 1 above, provided that you also meet all of these conditions:

- a) The modified work must itself be a software library.
- b) You must cause the files modified to carry prominent notices stating that you changed the files and the date of any change.
- c) You must cause the whole of the work to be licensed at no charge to all third parties under the terms of this License.
- d) If a facility in the modified Library refers to a function or a table of data to be supplied by an application program that uses the facility, other than as an argument passed when the facility is invoked, then you must make a good faith effort to ensure that, in the event an application does not supply such function or table, the facility still operates, and performs whatever part of its purpose remains meaningful.

(For example, a function in a library to compute square roots has a purpose that is entirely well-defined independent of the application. Therefore, Subsection 2d requires that any application-supplied function or table used by this function must be optional: if the application does not supply it, the square root function must still compute square roots.)

These requirements apply to the modified work as a whole. If identifiable sections of that work are not derived from the Library, and can be reasonably considered independent and separate works in themselves, then this License, and its terms, do not apply to those sections when you distribute them as separate works. But when you distribute the same sections as part of a whole which is a work based on the Library, the distribution of the whole must be on the terms of this License, whose permissions for other licensees extend to the entire whole, and thus to each and every part regardless of who wrote it.

Thus, it is not the intent of this section to claim rights or contest your rights to work written entirely by you; rather, the intent is to exercise the right to control the distribution of derivative or collective works based on the Library.

In addition, mere aggregation of another work not based on the Library with the Library (or with a work based on the Library) on a volume of a storage or distribution medium does not bring the other work under the scope of this License.

- 3.** You may opt to apply the terms of the ordinary GNU General Public License instead of this License to a given copy of the Library. To do this, you must alter all the notices that refer to this License, so that they refer to the ordinary GNU General Public License, version 2, instead of to this License. (If a newer version than version 2 of the ordinary GNU General Public License has appeared, then you can specify that version instead if you wish.) Do not make any other change in these notices.

Once this change is made in a given copy, it is irreversible for that copy, so the ordinary GNU General Public License applies to all subsequent copies and derivative works made from that copy.

This option is useful when you wish to copy part of the code of the Library into a program that is not a library.

- 4.** You may copy and distribute the Library (or a portion or derivative of it, under Section 2) in object code or executable form under the terms of Sections 1 and 2 above provided that you accompany it with the complete corresponding machine-readable source code, which must be distributed under the terms of Sections 1 and 2 above on a medium customarily used for software interchange.

If distribution of object code is made by offering access to copy from a designated place, then offering equivalent access to copy the source code from the same place satisfies the requirement to distribute the source code, even though third parties are not compelled to copy the source along with the object code.

- 5.** A program that contains no derivative of any portion of the Library, but is designed to work with the Library by being compiled or linked with it, is called a “work that uses the Library”. Such a work, in isolation, is not a derivative work of the Library, and therefore falls outside the scope of this License.

However, linking a “work that uses the Library” with the Library creates an executable that is a derivative of the Library (because it contains portions of the Library), rather than a “work that uses the library”. The executable is therefore covered by this License. Section 6 states terms for distribution of such executables.

When a “work that uses the Library” uses material from a header file that is part of the Library, the object code for the work may be a derivative work of the Library even though the source code is not. Whether this is true is especially significant if the work can be linked without the Library, or if the work is itself a library. The threshold for this to be true is not precisely defined by law.

If such an object file uses only numerical parameters, data structure layouts and accessors, and small macros and small inline functions (ten lines or less in length), then the use of the object file is unrestricted, regardless of whether it is legally a derivative work. (Executables containing this object code plus portions of the Library will still fall under Section 6.)

Otherwise, if the work is a derivative of the Library, you may distribute the object code for the work under the terms of Section 6. Any executables containing that work also fall under Section 6, whether or not they are linked directly with the Library itself.

- 6.** As an exception to the Sections above, you may also combine or link a “work that uses the Library” with the Library to produce a work containing portions of the Library, and distribute that work under terms of your choice, provided that the terms permit modification of the work for the customer’s own use and reverse engineering for debugging such modifications.

You must give prominent notice with each copy of the work that the Library is used in it and that the Library and its use are covered by this License. You must supply a copy of this License. If the work during execution displays copyright notices, you must include the copyright notice for the Library among them, as well as a reference directing the user to the copy of this License. Also, you must do one of these things:

- a) Accompany the work with the complete corresponding machine-readable source code for the Library including whatever changes were used in the work (which must be distributed under Sections 1 and 2 above); and, if the work is an executable linked with the Library, with the complete machinereadable “work that uses the Library”, as object code and/or source code, so that the user can modify the Library and then relink to produce a modified executable containing the modified Library. (It is understood that the user who changes the contents of definitions files in the Library will not necessarily be able to recompile the application to use the modified definitions.)
- b) Use a suitable shared library mechanism for linking with the Library. A suitable mechanism is one that (1) uses at run time a copy of the library already present on the user’s computer system, rather than copying library functions into the executable, and (2) will operate properly with a modified version of the library, if the user installs one, as long as the modified version is interface-compatible with the version that the work was made with.
- c) Accompany the work with a written offer, valid for at least three years, to give the same user the materials specified in Subsection 6a, above, for a charge no more than the cost of performing this distribution.
- d) If distribution of the work is made by offering access to copy from a designated place, offer equivalent access to copy the above specified materials from the same place.
- e) Verify that the user has already received a copy of these materials or that you have already sent this user a copy.

For an executable, the required form of the “work that uses the Library” must include any data and utility programs needed for reproducing the executable from it. However, as a special exception, the materials to be distributed need not include anything that is normally distributed (in either source or binary form) with the major components (compiler, kernel, and so on) of the operating system on which the executable runs, unless that component itself accompanies the executable.

It may happen that this requirement contradicts the license restrictions of other proprietary libraries that do not normally accompany the operating system. Such a contradiction means you cannot use both them and the Library together in an executable that you distribute.

**7.** You may place library facilities that are a work based on the Library side-by-side in a single library together with other library facilities not covered by this License, and distribute such a combined library, provided that the separate distribution of the work based on the Library and of the other library facilities is otherwise permitted, and provided that you do these two things:

- a) Accompany the combined library with a copy of the same work based on the Library, uncombined with any other library facilities. This must be distributed under the terms of the Sections above.
- b) Give prominent notice with the combined library of the fact that part of it is a work based on the Library, and explaining where to find the accompanying uncombined form of the same work.

**8.** You may not copy, modify, sublicense, link with, or distribute the Library except as expressly provided under this License. Any attempt otherwise to copy, modify, sublicense, link with, or distribute the Library is void, and will automatically terminate your rights under this License. However, parties who have received copies, or rights, from you under this License will not have their licenses terminated so long as such parties remain in full compliance.

**9.** You are not required to accept this License, since you have not signed it. However, nothing else grants you permission to modify or distribute the Library or its derivative works. These actions are prohibited by law if you do not accept this License. Therefore, by modifying or distributing the Library (or any work based on the Library), you indicate your acceptance of this License to do so, and all its terms and conditions for copying, distributing or modifying the Library or works based on it.

**10.** Each time you redistribute the Library (or any work based on the Library), the recipient automatically receives a license from the original licensor to copy, distribute, link with or modify the Library subject to these terms and conditions. You may not impose any further restrictions on the recipients’ exercise of the rights granted herein. You are not responsible for enforcing compliance by third parties with this License.

**11.** If, as a consequence of a court judgment or allegation of patent infringement or for any other reason (not limited to patent issues), conditions are imposed on you (whether by court order, agreement or otherwise) that contradict the conditions of this License, they do not excuse you from the conditions of this License. If you cannot distribute so as to satisfy simultaneously your obligations under this License and any other pertinent obligations, then as a consequence you may not distribute the Library at all. For example, if a patent license would not permit royalty-free redistribution of the Library by all those who receive copies directly or indirectly through you, then the only way you could satisfy both it and this License would be to refrain entirely from distribution of the Library.

If any portion of this section is held invalid or unenforceable under any particular circumstance, the balance of the section is intended to apply, and the section as a whole is intended to apply in other circumstances.

It is not the purpose of this section to induce you to infringe any patents or other property right claims or to contest validity of any such claims; this section has the sole purpose of protecting the integrity of the free software distribution system which is implemented by public license practices. Many people have made generous contributions to the wide range of software distributed through that system in reliance on consistent application of that system; it is up to the author/donor to decide if he or she is willing to distribute software through any other system and a licensee cannot impose that choice.

This section is intended to make thoroughly clear what is believed to be a consequence of the rest of this License.

**12.** If the distribution and/or use of the Library is restricted in certain countries either by patents or by copyrighted interfaces, the original copyright holder who places the Library under this License may add an explicit geographical distribution limitation excluding those countries, so that distribution is permitted only in or among countries not thus excluded. In such case, this License incorporates the limitation as if written in the body of this License.

**13.** The Free Software Foundation may publish revised and/or new versions of the Lesser General Public License from time to time. Such new versions will be similar in spirit to the present version, but may differ in detail to address new problems or concerns.

Each version is given a distinguishing version number. If the Library specifies a version number of this License which applies to it and "any later version", you have the option of following the terms and conditions either of that version or of any later version published by the Free Software Foundation. If the Library does not specify a license version number, you may choose any version ever published by the Free Software Foundation.

**14.** If you wish to incorporate parts of the Library into other free programs whose distribution conditions are incompatible with these, write to the author to ask for permission. For software which is copyrighted by the Free Software Foundation, write to the Free Software Foundation; we sometimes make exceptions for this. Our decision will be guided by the two goals of preserving the free status of all derivatives of our free software and of promoting the sharing and reuse of software generally.

## **NO WARRANTY**

**15.** BECAUSE THE LIBRARY IS LICENSED FREE OF CHARGE, THERE IS NO WARRANTY FOR THE LIBRARY, TO THE EXTENT PERMITTED BY APPLICABLE LAW. EXCEPT WHEN OTHERWISE STATED IN WRITING THE COPYRIGHT HOLDERS AND/OR OTHER PARTIES PROVIDE THE LIBRARY "AS IS" WITHOUT WARRANTY OF ANY KIND, EITHER EXPRESSED OR IMPLIED, INCLUDING, BUT NOT LIMITED TO, THE IMPLIED WARRANTIES OF MERCHANTABILITY AND FITNESS FOR A PARTICULAR PURPOSE. THE ENTIRE RISK AS TO THE QUALITY AND PERFORMANCE OF THE LIBRARY IS WITH YOU. SHOULD THE LIBRARY PROVE DEFECTIVE, YOU ASSUME THE COST OF ALL NECESSARY SERVICING, REPAIR OR CORRECTION.

**16.** IN NO EVENT UNLESS REQUIRED BY APPLICABLE LAW OR AGREED TO IN WRITING WILL ANY COPYRIGHT HOLDER, OR ANY OTHER PARTY WHO MAY MODIFY AND/OR REDISTRIBUTE THE LIBRARY AS PERMITTED ABOVE, BE LIABLE TO YOU FOR DAMAGES, INCLUDING ANY GENERAL, SPECIAL, INCIDENTAL OR CONSEQUENTIAL DAMAGES ARISING OUT OF THE USE OR INABILITY TO USE THE LIBRARY (INCLUDING BUT NOT LIMITED TO LOSS OF DATA OR DATA BEING RENDERED INACCURATE OR LOSSES SUSTAINED BY YOU OR THIRD PARTIES OR A FAILURE OF THE LIBRARY TO OPERATE WITH ANY OTHER SOFTWARE), EVEN IF SUCH HOLDER OR OTHER PARTY HAS BEEN ADVISED OF THE POSSIBILITY OF SUCH DAMAGES.

## **END OF TERMS AND CONDITIONS**

### **How to Apply These Terms to Your New Libraries**

If you develop a new library, and you want it to be of the greatest possible use to the public, we recommend making it free software that everyone can redistribute and change. You can do so by permitting redistribution under these terms (or, alternatively, under the terms of the ordinary General Public License).

To apply these terms, attach the following notices to the library. It is safest to attach them to the start of each source file to most effectively convey the exclusion of warranty; and each file should have at least the "copyright" line and a pointer to where the full notice is found.

<one line to give the library's name and an idea of what it does.> Copyright (C) <year> <name of author>

This library is free software; you can redistribute it and/or modify it under the terms of the GNU Lesser General Public License as published by the Free Software Foundation; either version 2.1 of the License, or (at your option) any later version.

This library is distributed in the hope that it will be useful, but WITHOUT ANY WARRANTY; without even the implied warranty of MERCHANTABILITY or FITNESS FOR A PARTICULAR PURPOSE. See the GNU Lesser General Public License for more details.

You should have received a copy of the GNU Lesser General Public License along with this library; if not, write to the Free Software Foundation, Inc., 59 Temple Place, Suite 330, Boston, MA 02111-1307 USA

Also add information on how to contact you by electronic and paper mail.

You should also get your employer (if you work as a programmer) or your school, if any, to sign a "copyright disclaimer" for the library, if necessary. Here is a sample; alter the names:

Yoyodyne, Inc., hereby disclaims all copyright interest in the library 'Frob' (a library for tweaking knobs) written by James Random Hacker.

signature of Ty Coon, 1 April 1990

Ty Coon, President of Vice

That's all there is to it!

## OpenSSL License

Copyright (c) 1998-2007 The OpenSSL Project. All rights reserved.

Redistribution and use in source and binary forms, with or without modification, are permitted provided that the following conditions are met:

1. Redistributions of source code must retain the above copyright notice, this list of conditions and the following disclaimer.
2. Redistributions in binary form must reproduce the above copyright notice, this list of conditions and the following disclaimer in the documentation and/or other materials provided with the distribution.
3. All advertising materials mentioning features or use of this software must display the following acknowledgment: "This product includes software developed by the OpenSSL Project for use in the OpenSSL Toolkit. (<http://www.openssl.org/>)"
4. The names "OpenSSL Toolkit" and "OpenSSL Project" must not be used to endorse or promote products derived from this software without prior written permission. For written permission, please contact [openssl-core@openssl.org](mailto:openssl-core@openssl.org).
5. Products derived from this software may not be called "OpenSSL" nor may "OpenSSL" appear in their names without prior written permission of the OpenSSL Project.
6. Redistributions of any form whatsoever must retain the following acknowledgment: "This product includes software developed by the OpenSSL Project for use in the OpenSSL Toolkit (<http://www.openssl.org/>)"

THIS SOFTWARE IS PROVIDED BY THE OpenSSL PROJECT "AS IS" AND ANY EXPRESSED OR IMPLIED WARRANTIES, INCLUDING, BUT NOT LIMITED TO, THE IMPLIED WARRANTIES OF MERCHANTABILITY AND FITNESS FOR A PARTICULAR PURPOSE ARE DISCLAIMED. IN NO EVENT SHALL THE OpenSSL PROJECT OR ITS CONTRIBUTORS BE LIABLE FOR ANY DIRECT, INDIRECT, INCIDENTAL, SPECIAL, EXEMPLARY, OR CONSEQUENTIAL DAMAGES (INCLUDING, BUT NOT LIMITED TO, PROCUREMENT OF SUBSTITUTE GOODS OR SERVICES; LOSS OF USE, DATA, OR PROFITS; OR BUSINESS INTERRUPTION) HOWEVER CAUSED AND ON ANY THEORY OF LIABILITY, WHETHER IN CONTRACT, STRICT LIABILITY, OR TORT (INCLUDING NEGLIGENCE OR OTHERWISE) ARISING IN ANY WAY OUT OF THE USE OF THIS SOFTWARE, EVEN IF ADVISED OF THE POSSIBILITY OF SUCH DAMAGE.

## LIMITED WARRANTY TO ORIGINAL PURCHASER

This SAMSUNG brand product, as supplied and distributed by SAMSUNG ELECTRONICS AMERICA, INC. (SAMSUNG) and delivered new, in the original carton to the original consumer purchaser, is warranted by SAMSUNG against manufacturing defects in materials and workmanship for the following limited warranty period:

### **One (1) Year Parts / Ninety Days (90) Labor**

This limited warranty begins on the original date of purchase, and is valid only on products purchased and used in the United States, and does not include transportation, installation, removal or reinstallation. Warranty repairs must be performed by SAMSUNG's authorized service center. To receive warranty service, the original dated bill of sale must be presented upon request as proof of purchase to SAMSUNG or SAMSUNG's authorized service center. Transportation to and from the service center is the responsibility of the purchaser.

SAMSUNG will repair or replace this product, at our option and at no charge with new or reconditioned parts, if found to be defective during the limited warranty period specified above. The product must be returned during the warranty period with transportation charges prepaid to SAMSUNG's designated service center. Prior to returning any product for warranty service, the purchaser must contact SAMSUNG for problem determination and service procedures. SAMSUNG does not warrant uninterrupted or error-free operation of the product.

All replaced parts and products become the property of SAMSUNG and must be returned to SAMSUNG. Replacement parts and products assume the remaining original warranty, or ninety (90) days, whichever is longer.

This limited warranty covers manufacturing defects in materials and workmanship encountered in normal, noncommercial use of this product and shall not apply to the following, including, but not limited to: damage which occurs in shipment; applications and uses for which this product was not intended; failures or problems which are caused by products or equipment not supplied by SAMSUNG; accidents, misuse, abuse, neglect, misapplication, fire, water, lightning or other acts of nature; incorrect electrical line voltage, fluctuations or surges; damage caused by improper or faulty installation; improper connection with any peripheral; product alteration or modification; improper or unauthorized repair; cosmetic damage or exterior finish; product with altered serial numbers; failure to follow operating instructions, customer adjustments, maintenance and environmental instructions that are covered and prescribed in the instruction book; use of non-SAMSUNG or unauthorized parts, supplies, accessories or equipment which damage this product or result in service problems; failures or problems due to incompatibility with other equipment.

No person, agent, distributor, dealer or company is authorized to change, modify or extend the terms of these warranties in any manner whatsoever. The time within which an action must be commenced to enforce any obligations of SAMSUNG arising under the warranty or under any statute, or law of the United States or of any state thereof, is hereby limited to ninety (90) days from the date you discovered or should have discovered the defect. This limitation does not apply to implied warranties arising under state law, if any.

SAMSUNG does not warrant (i) disc compatibility with new and existing format discs or (ii) error free playback in full compliance with specifications of the compatible disc formats, and SAMSUNG shall not be liable for any data loss recorded in your discs. SAMSUNG's responsibility shall be limited to appropriate warranty services during the warranty period through SAMSUNG customer care center. If you encounter compatibility or data loss problems, please contact SAMSUNG customer care center.

THERE ARE NO EXPRESS WARRANTIES OTHER THAN THOSE LISTED AND DESCRIBED ABOVE, AND NO WARRANTIES WHETHER EXPRESS OR IMPLIED, INCLUDING, BUT NOT LIMITED TO, ANY IMPLIED WARRANTIES OF MERCHANTABILITY OR FITNESS FOR A PARTICULAR PURPOSE, SHALL APPLY AFTER THE EXPRESS WARRANTY PERIODS STATED ABOVE, AND NO OTHER EXPRESS WARRANTY OR GUARANTY GIVEN BY ANY PERSON, FIRM OR CORPORATION WITH RESPECT TO THIS PRODUCT SHALL BE BINDING ON SAMSUNG. SAMSUNG SHALL NOT BE LIABLE FOR LOSS OF REVENUE OR PROFITS, FAILURE TO REALIZE SAVINGS OR OTHER BENEFITS, OR ANY OTHER SPECIAL, INCIDENTAL OR CONSEQUENTIAL DAMAGES CAUSED BY THE USE, MISUSE OR INABILITY TO USE THIS PRODUCT, REGARDLESS OF THE LEGAL THEORY ON WHICH THE CLAIM IS BASED, AND EVEN IF SAMSUNG HAS BEEN ADVISED OF THE POSSIBILITY OF SUCH DAMAGES. NOR SHALL RECOVERY OF ANY KIND AGAINST SAMSUNG BE GREATER IN AMOUNT THAN THE PURCHASE PRICE OF THE PRODUCT SOLD BY SAMSUNG AND CAUSING THE ALLEGED DAMAGE. WITHOUT LIMITING THE FOREGOING, PURCHASER ASSUMES ALL RISK AND LIABILITY FOR LOSS, DAMAGE OR INJURY TO PURCHASER AND PURCHASER'S PROPERTY AND TO OTHERS AND THEIR PROPERTY ARISING OUT OF THE USE, MISUSE OR INABILITY TO USE THIS PRODUCT SOLD BY SAMSUNG NOT CAUSED DIRECTLY BY THE NEGLIGENCE OF SAMSUNG. THIS LIMITED WARRANTY SHALL NOT EXTEND TO ANYONE OTHER THAN THE ORIGINAL PURCHASER OF THIS PRODUCT, IS NONTRANSFERABLE AND STATES YOUR EXCLUSIVE REMEDY.

Some states do not allow limitations on how long an implied warranty lasts, or the exclusion or limitation of incidental or consequential damages, so the above limitations or exclusions may not apply to you. This warranty gives you specific legal rights, and you may also have other rights which vary from state to state.

To obtain warranty service, please contact SAMSUNG customer care center.

## Contact SAMSUNG WORLD WIDE

If you have any questions or comments relating to Samsung products, please contact the SAMSUNG customer care center.

Region	Country	Contact Center ☎	Web Site
North America	CANADA	1-800-SAMSUNG(726-7864)	www.samsung.com/ca
	MEXICO	01-800-SAMSUNG(726-7864)	www.samsung.com/mx
	U.S.A	1-800-SAMSUNG(726-7864)	www.samsung.com/us
Latin America	ARGENTINE	0800-333-3733	www.samsung.com/ar
	BRAZIL	0800-124-421, 4004-0000	www.samsung.com/br
	CHILE	800-SAMSUNG(726-7864)	www.samsung.com/cl
	NICARAGUA	00-1800-5077267	www.samsung.com/latin
	HONDURAS	800-7919267	www.samsung.com/latin
	COSTA RICA	0-800-507-7267	www.samsung.com/latin
	ECUADOR	1-800-10-7267	www.samsung.com/latin
	EL SALVADOR	800-6225	www.samsung.com/latin
	GUATEMALA	1-800-299-0013	www.samsung.com/latin
	JAMAICA	1-800-234-7267	www.samsung.com/latin
	PANAMA	800-7267	www.samsung.com/latin
	PUERTO RICO	1-800-682-3180	www.samsung.com/latin
	REP. DOMINICA	1-800-751-2676	www.samsung.com/latin
TRINIDAD & TOBAGO	1-800-SAMSUNG(726-7864)	www.samsung.com/latin	
VENEZUELA	0-800-100-5303	www.samsung.com/latin	
COLOMBIA	01-8000112112	www.samsung.com.co	
Europe	BELGIUM	02 201 2418	www.samsung.com/be (Dutch) www.samsung.com/be_fr (French)
	CZECH REPUBLIC	800-SAMSUNG(800-726786)	www.samsung.com/cz
	DENMARK	8-SAMSUNG(7267864)	www.samsung.com/dk
	FINLAND	30-6227 515	www.samsung.com/fi
	FRANCE	01 4863 0000	www.samsung.com/fr
	GERMANY	01805 - SAMSUNG(726-7864 € 0,14/Min)	www.samsung.de
	HUNGARY	06-80-SAMSUNG(726-7864)	www.samsung.com/hu
	ITALIA	800-SAMSUNG(726-7864)	www.samsung.com/it
	LUXEMBURG	02 261 03 710	www.samsung.com/lu
	NETHERLANDS	0900-SAMSUNG (0900-7267864) (€ 0,10/Min)	www.samsung.com/nl
	NORWAY	3-SAMSUNG(7267864)	www.samsung.com/no
	POLAND	0 801 1SAMSUNG(172678), 022-607-93-33	www.samsung.com/pl
	PORTUGAL	80820-SAMSUNG(726-7864)	www.samsung.com/pt
	SLOVAKIA	0800-SAMSUNG(726-7864)	www.samsung.com/sk
	SPAIN	902-1-SAMSUNG (902 172 678)	www.samsung.com/es
	SWEDEN	075-SAMSUNG(726 78 64)	www.samsung.com/se
	U.K	0845 SAMSUNG (7267864)	www.samsung.com/uk
EIRE	0818 717 100	www.samsung.com/ie	
AUSTRIA	0810-SAMSUNG(7267864, € 0.07/min)	www.samsung.com/at	
SWITZERLAND	0848-SAMSUNG(7267864, CHF 0.08/min)	www.samsung.com/ch	
CIS	RUSSIA	8-800-555-55-55	www.samsung.ru
	KAZAKHSTAN	8-10-800-500-55-500	www.samsung.com/kz_ru
	UZBEKISTAN	8-10-800-500-55-500	www.samsung.com/kz_ru
	KYRGYZSTAN	00-800-500-55-500	
	TADJIKISTAN	8-10-800-500-55-500	
	UKRAINE	8-800-502-0000	www.samsung.ua
	LITHUANIA	8-800-77777	www.samsung.com/lt
	LATVIA	8000-7267	www.samsung.com/lv
ESTONIA	800-7267	www.samsung.com/ee	
Asia Pacific	AUSTRALIA	1300 362 603	www.samsung.com/au
	NEW ZEALAND	0800 SAMSUNG (0800 726 786)	www.samsung.com/nz
	CHINA	800-810-5858, 400-810-5858, 010-6475 1880	www.samsung.com/cn
	HONG KONG	3698-4698	www.samsung.com/hk
	INDIA	3030 8282, 1800 110011, 1-800-3000-8282	www.samsung.com/in
	INDONESIA	0800-112-8888	www.samsung.com/id
	JAPAN	0120-327-527	www.samsung.com/jp
	MALAYSIA	1800-88-9999	www.samsung.com/my
	PHILIPPINES	1-800-10-SAMSUNG(726-7864) 1-800-3-SAMSUNG(726-7864), 02-5805777	www.samsung.com/ph
	SINGAPORE	1800-SAMSUNG(726-7864)	www.samsung.com/sg
	THAILAND	1800-29-3232, 02-689-3232	www.samsung.com/th
TAIWAN	0800-329-999	www.samsung.com/tw	
VIETNAM	1 800 588 889	www.samsung.com/vn	
Middle East & Africa	TURKEY	444 77 11	www.samsung.com/tr
	SOUTH AFRICA	0860-SAMSUNG(726-7864)	www.samsung.com/za
	U.A.E	800-SAMSUNG (726-7864), 8000-4726	www.samsung.com/ae





QUESTIONS OR COMMENTS?

COUNTRY	CALL	OR VISIT US ONLINE AT	WRITE
IN THE US	1-800-SAMSUNG (7267864)	<a href="http://www.samsung.com">www.samsung.com</a>	Samsung Electronics America, Inc. 105 Challenger Road Ridgefield Park, NJ 07660-0511

